

Sliding Gate Opener

User Manual

SL500DC/SL800DC

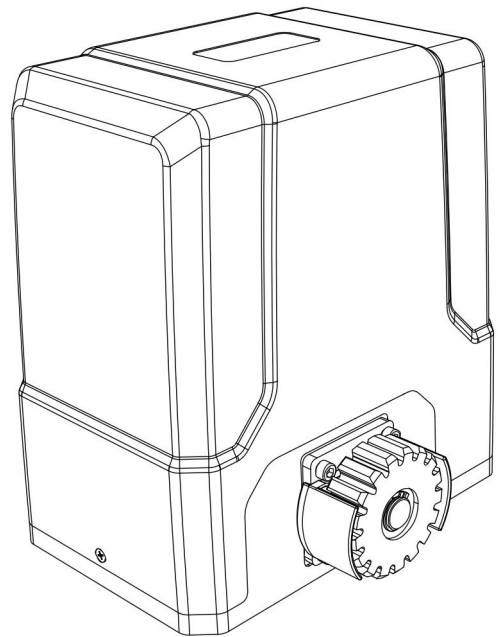
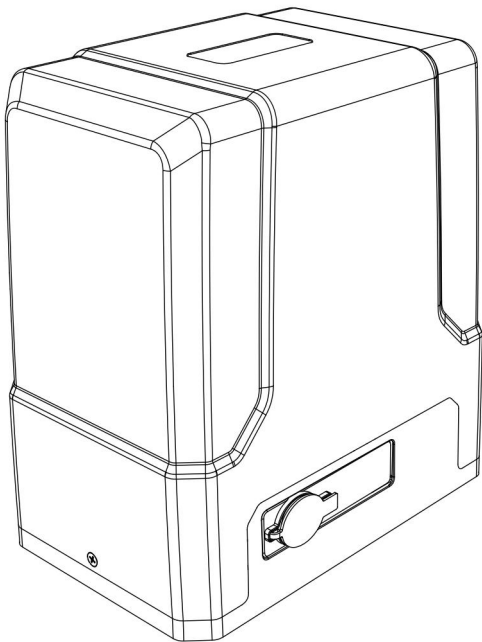

WARNING

Instructions must be read before installation. Please follow these instructions carefully, incorrect installation could affect gate operation.

When mounting and positioning this product please ensure the power cable is unplugged.

The motor cover will need to be removed to mount the motor to the mounting plate or directly to the concrete footing. Any changes to the settings on this product can only be made by a licensed electrician.

CONTENTS

Default Setting Instruction	1
Safety Instruction	2
Parts List	3
Technical Parameters	4
Installation	5
Before You Start.....	5
Tools Required / Example Sliding Gate.....	5
Step 1 - Gate Preparation.....	6
Step 2 - Checking Manual Release.....	6
Step 3 - Removing / Installing Motor Cover.....	6
Step 4 – Motor Pad Footing.....	7
Step 5 - Fitting Mounting Plate and Motor.....	7
Step 6 - Gear Rack & Motor Alignment.....	9
Step 7 - Limit Switch Stop.....	10
Step 8 - Powering on.....	12
Step 9 - Testing Travel and Limit Stop Position.....	13
Programming and Wiring	14
Terminal Instructions.....	15
Wiring to the Terminal.....	15
Connecting Infrared Photocells.....	17
Operation Interface Instruction.....	18
Manual Control Mode.....	19
Quick Setting for Running Travel.....	20
Remote Control Management.....	21
Single Button Mode Learning(L1).....	22
Three-Button Mode Learning(L2).....	23
Pedestrian Mode on Remote Control(L3).....	24
Remote Control Delete(L4).....	25
Remote Control Quick Learning.....	26
Basic Menu Setting.....	27
Running Speed Setting(L1).....	28
Slow Stop Speed Setting(L2).....	29
Reverse When Meeting Obstacles Setting (L3).....	30
Slow Stop Distance Setting (L4).....	31
Auto-close Function Setting (L5).....	32
Advanced Menu Setting.....	34

Working Mode Setting (L1).....	34
Acceleration Setting (L2).....	36
Start-up Delay Setting (L3).....	37
Opening Direction Setting (L4).....	39
Alarm Lamp Setting(L5).....	40
Other Menu Setting.....	41
Emergency Stop Distance Setting(L1).....	42
Buzzer Setting(L2).....	43
Battery Level Checking.....	45
Restore Factory Setting.....	46
Control Board Error Instruction.....	47
Maintenance	47
Troubleshooting	48
Drawing and Measurements	49

Default Setting Instruction

The gate opener will open the gate to the right-hand side as its default setting. By default, the opener mounts on the right-hand side. (Figure 1)

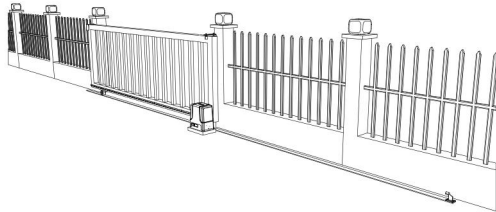

Gate in closed position

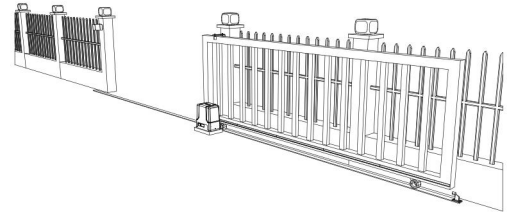

Gate in open position

Figure 1

Before installation: Test the gate opener by plugging it into a power source and pressing the remote. Press the opening button, the output gear rotates, then press the stop button, the output gear stops rotating. Finally, press the closing button, the output gear rotates to the opposite direction. This will give you an understanding of the way in which the opener will move the gate.

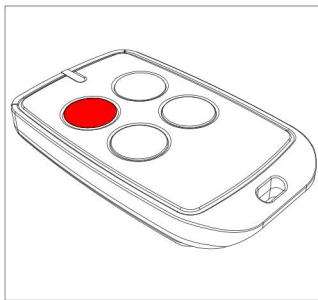

Press the first/top button on the remote.

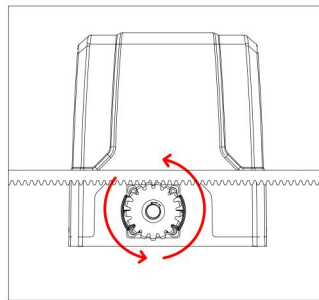

Rotating output gear will drive the gate frame.

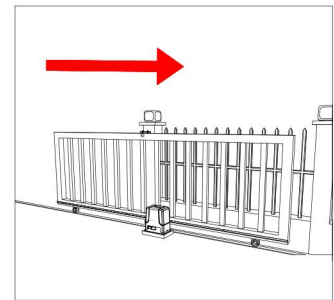

Then the gate will move in the set direction.

Figure 2

Note: Ensure that the gate opener is unplugged before proceeding with installation. Please keep fingers away from the motor output gear whilst it is turning.

If your gate needs to open from the other direction (to the left, refer to figure 3), your opener needs to be mounted on the left-hand side as shown.

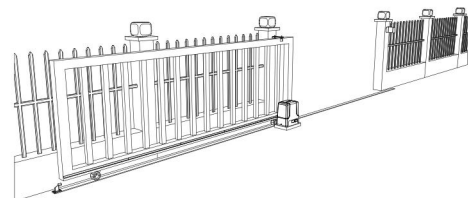
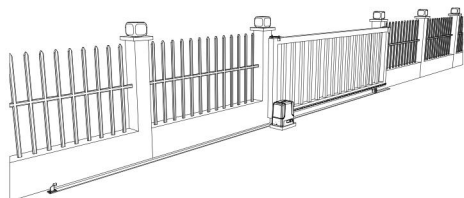

Figure 3

Any works done to the gate opener must be completed whilst the power is off, and the opener is unplugged.











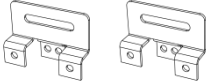

Safety Instruction

Warning: Incorrect or improper use of this product can cause damage to persons, animals or properties.

- Please ensure that the input voltage used matches with the supply voltage of gate opener.
- All modifications to wiring or electrics, and any adjustment or maintenance to input voltage must be done by a qualified electrician.
- All potential hazards and exposed pinch points of the gate must be eliminated or guarded prior to installation of this gate opener.
- Never mount any device that operates the gate opener where the user can reach over (under, around or through) the gate to operate the controls. These must be placed away from any moving range of the moving gate.
- Ensure power plug is disconnected from the power socket during installation or maintenance.
- Keep remote control and other control devices out of children's reach, in order to avoid unintentional activation.
- To ensure safety, before installing the motor, mount a Gate End Catch and a Gate Stop at each end of the rail to prevent the gate travelling off the track.
- If required, install infrared photocell to detect obstructions and prevent injury to person or damage to property.
- Instruct all users about the control systems provided and the manual opening operation in case of emergency.
- Ensure that the power cable is connected to a RCD protected weatherproof power outlet installed by a qualified electrician.
- Do not install this product in an explosive atmosphere or where there is any danger of flooding.
- This product was exclusively designed and manufactured for the use specified in the present documentation. Any other use not specified in this documentation could damage the product and be dangerous.
- Only use original parts for any maintenance or repair operation. Our company declines all responsibility with respect to the automation safety and correct operation when other supplier's components are used.
- Do not modify the automation components, unless explicitly authorized by our company.
- The user must avoid any attempt to carry out any works or repairs on this product, and should always request the assistance of qualified personnel.
- This product is suitable for use on one sliding gate only.
- Anything which is not expressly provided for in these instructions is not allowed and will void warranty.
- Dispose of all packing materials (plastic, cardboard, polystyrene etc.) according to current guidelines. Keep plastic bags and polystyrene out of children's reach.
- Save these instructions for future use.



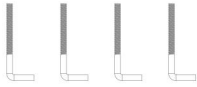
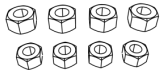

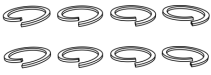

Parts List

Parts List (standard configuration)

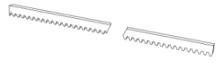
No.	Picture	Name	Quantity
1		Motor	1
2		Manual Release Keys	2
3		Remote Controls	2
4		Accessories Box	1
4-1		Limit Switch Stop Bracket	2
		Magnet Limit Switch Stop	2
		Magnet Limit Switch Stop Mounting Screws M6X18	2
		Nuts M8	4
		Flat Washers φ8	2
		Spring Washers φ8	2
5		Anchor Bolt M8	4
5-1		Nuts M8	8
5-2		Flat Washers φ8	8
5-3		Spring Washers φ8	8

Note: Extra flat washers and spring washers are spare parts.

Parts List (optional)

No.	Picture	Name	Quantity
1		Galvanized Gear Rack	1m/pc
2		Nylon Gear Rack	1m/pc
3		Infrared Photocell	1
4		Wireless Keypad	1
5		Alarm Lamp	1
6		Mounting Plate	1
7		Hexagon Head Bolt M8X40	4

Additional remote controls: Spare/Additional remotes for the automatic gate kit, these will need to be paired to the motor.

Infrared photocell: Detects pedestrians, vehicles and objects that cross an infrared beam and prevents the gate from closing.

Wireless keypad: Allows secure access through the gate used with a user set code.

Wired control: Allow users to control the opening and closing of the gate through an external push-button.

Alarm lamp: Alerts people near the gate and users that the gate is in operation.

Technical Parameters

Model	SL500DC	SL800DC
Power Supply	110VAC/60Hz; 220VAC/50Hz	
Motor Power	150W	170W
Gate Moving Speed	16-18m/min	
Maximum Loading Weight	500KG	800KG
Remote Control Distance	≥ 30m	
Remote Control Mode	Single button mode / Three button mode	
Limit Switch	Magnetic limit switch	
Working Noise	≤ 60dB	
Working Duty	S2, 20min	
Recording of up Remote Controls	32	
Remote Frequency	433.92 MHz	
Working Temperature	-20°C - +70°C	
Package Weight	10KG	11KG
Battery Specification	12V/9Ah × 1pc	

Installation

Before You Start

- SL500DC/SL800DC Sliding Gate Automation Kit is suitable for powering the opening and closing motion of gates up to 500, 800kg in weight, up to a length of 12m.
- Gate motion is achieved by the rotating output gear of the gate opener driving the gear rack (sold separately) fitted to the moving gate.
- The gate opener requires you to press the remote control once to open, and once again to close. This is a safety feature to ensure safe operation.
- The opener must be fitted within private property, never externally to a property's boundary.

Any works done to the gate opener must be completed whilst the power is off and the opener is unplugged. Any modifications/alterations/works to AC power components must only be completed by a licensed electrician

Tools Required

- Tape measure
- Level
- 12mm concrete drill and hammer (when uses expansion screws)
- Phillips head screwdriver
- Straight screwdriver

Example Sliding Gate

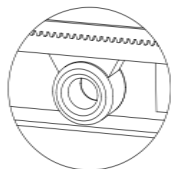
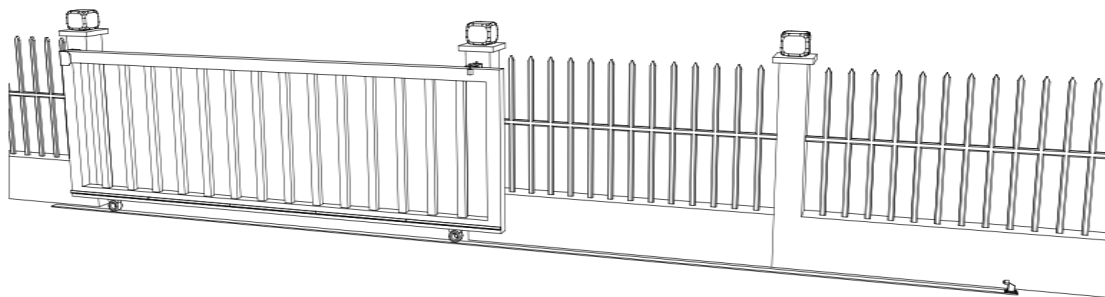

Gate Track and Track Wheels

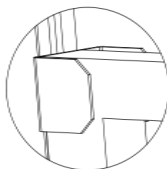

Gate End Catch

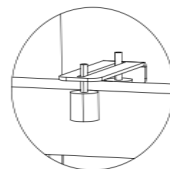

Gate Guide Rollers

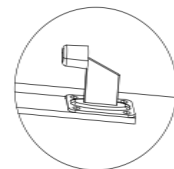

Gate Stop

Figure 4

Please ensure that the gate opener power cable is not plugged in at any stage before Step 8.

Step 1 - Gate Preparation

- Ensure that the sliding gate is correctly installed.
- The gate is horizontal and level and the gate can glide back and forth smoothly when moved by hand before installing the gate opener.
- Wheels and guide rollers should rotate easily and be free from dirt or grime.
- Track should be flat, level and firmly affixed.
- Any misalignment in the gate will affect performance of the automatic gate opener.

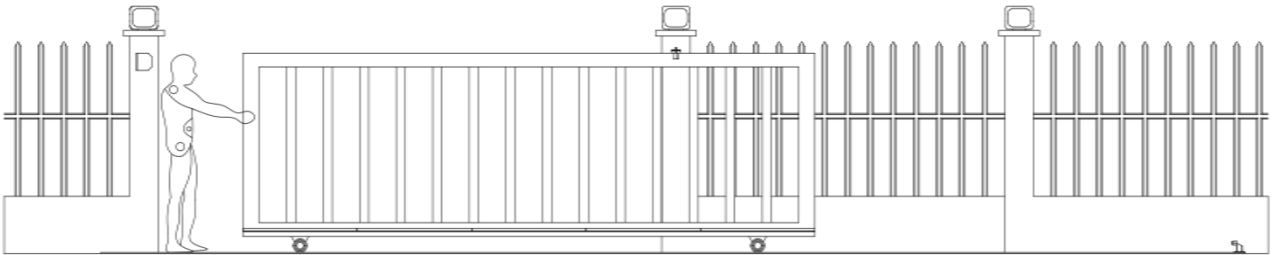

The gate should slide smoothly by hand before attempting to install the gate opener.

Figure 5

Step 2 - Checking Manual Release

- Insert the key and open the manual release bar to enable the motor get into manual mode and check that the motor output gear rotates freely by hand (Figure 6).

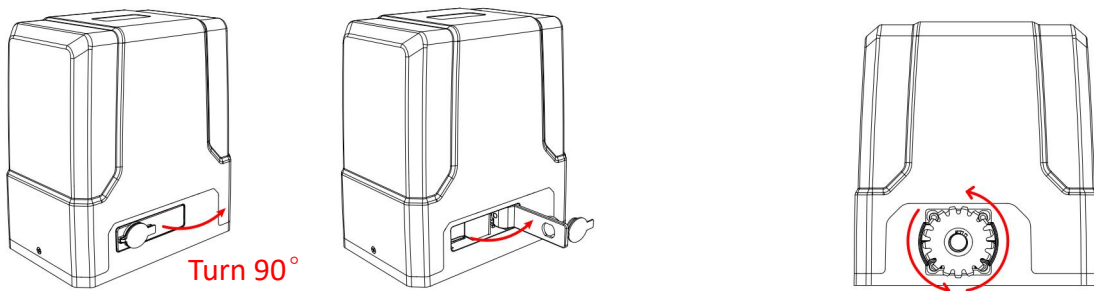

To make the motor into manual mode, insert the key and open the manual release bar till it rotates by 90° .

In manual mode, the gear can turn freely and the gate can be operated by hand.

Figure 6

Step 3 - Removing / Installing Motor Cover

- Unscrew the two cover screws located at each side of the motor cover.

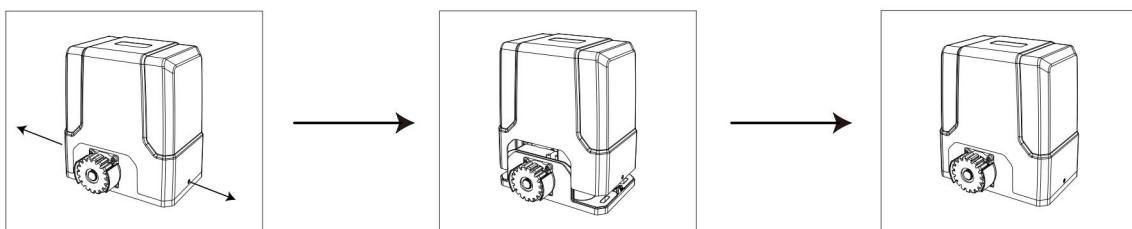
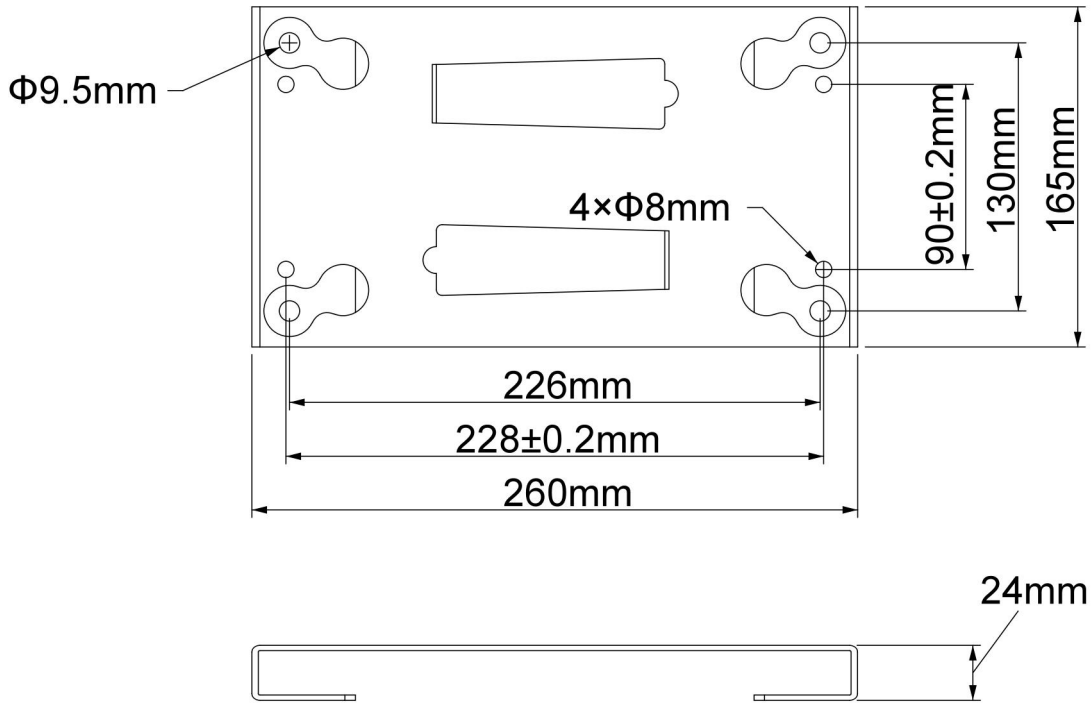

Figure 7

Step 4 - Motor Pad Footing

- The motor pad concrete footing requires an area of no less than 450mm long x 300mm wide and a minimum depth of 200mm (Standard requirement).
- Ensure surface is level and parallel to the driveway.



Mounting Plate Dimensions

Figure 8

Step 5 - Fitting Mounting Plate and Motor

Without Mounting Plate

- Pre-embed the anchor bolts according to holes in motor base before concreting (as per Figure 9).
- After concrete hardening, bolt the motor with M8x40mm bolts, spring and flat washers provided and tighten as required. (The height can be slightly adjusted by bottom bolts as per Figure 10).

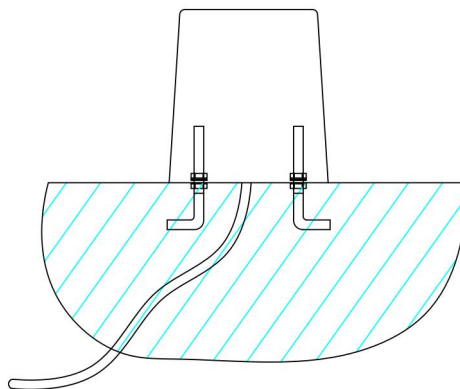
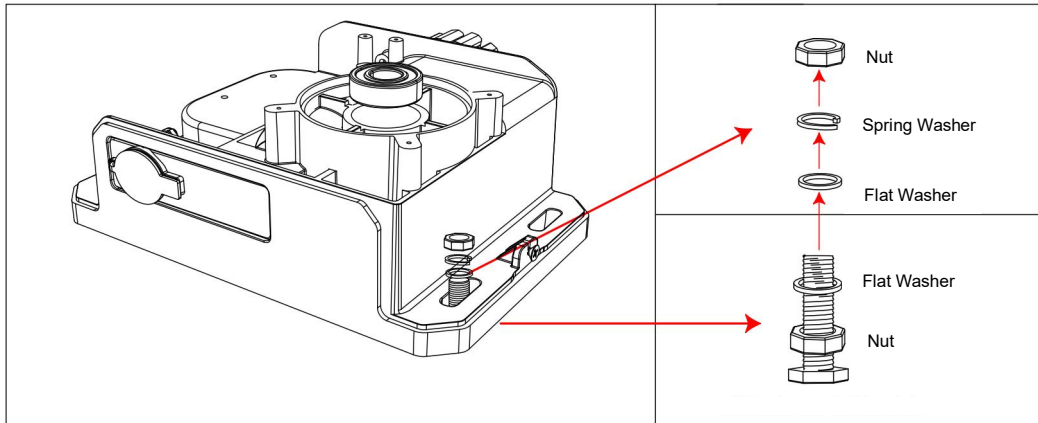

Figure 9



The bolts and flat washer between mounting plate and motor base are used for adjusting the height of the motor.

Figure 10

With Mounting Plate

- Pre embed the anchor bolts as per $\Phi 10$ holes in Figure 8 before concreting, after concrete hardening, place the mounting plate, fit and tighten anchor bolts.(as per figure 11).
- Bolt motor to the mounting plate using the M8 x 40mm bolts with spring and flat washers provided and tighten as required (as per figure 12).

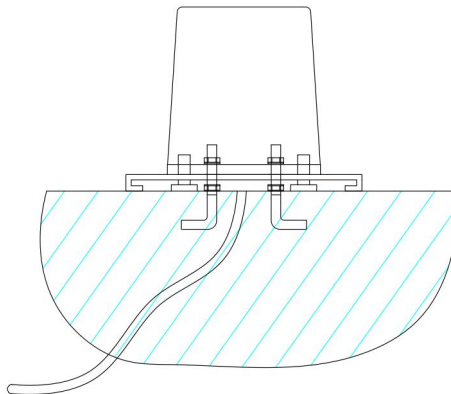
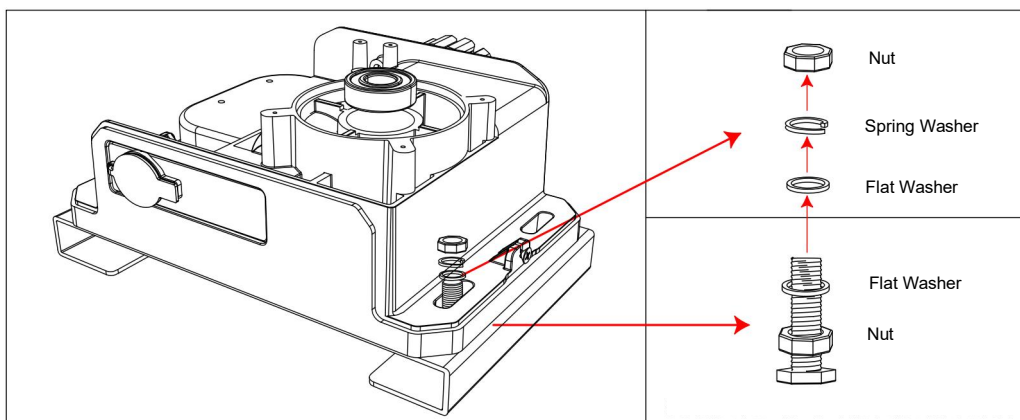

Figure 11



The bolts and flat washer between mounting plate and motor base are used for adjusting the height of the motor.

Figure 12

Fitting Motor

- Fit motor and mounting plate(if with) on the concrete footing.
- Ensure the motor output gear and gear rack are correctly aligned. Gear and gear rack should be centered as much as possible.
- Take the motor away from mounting plate.

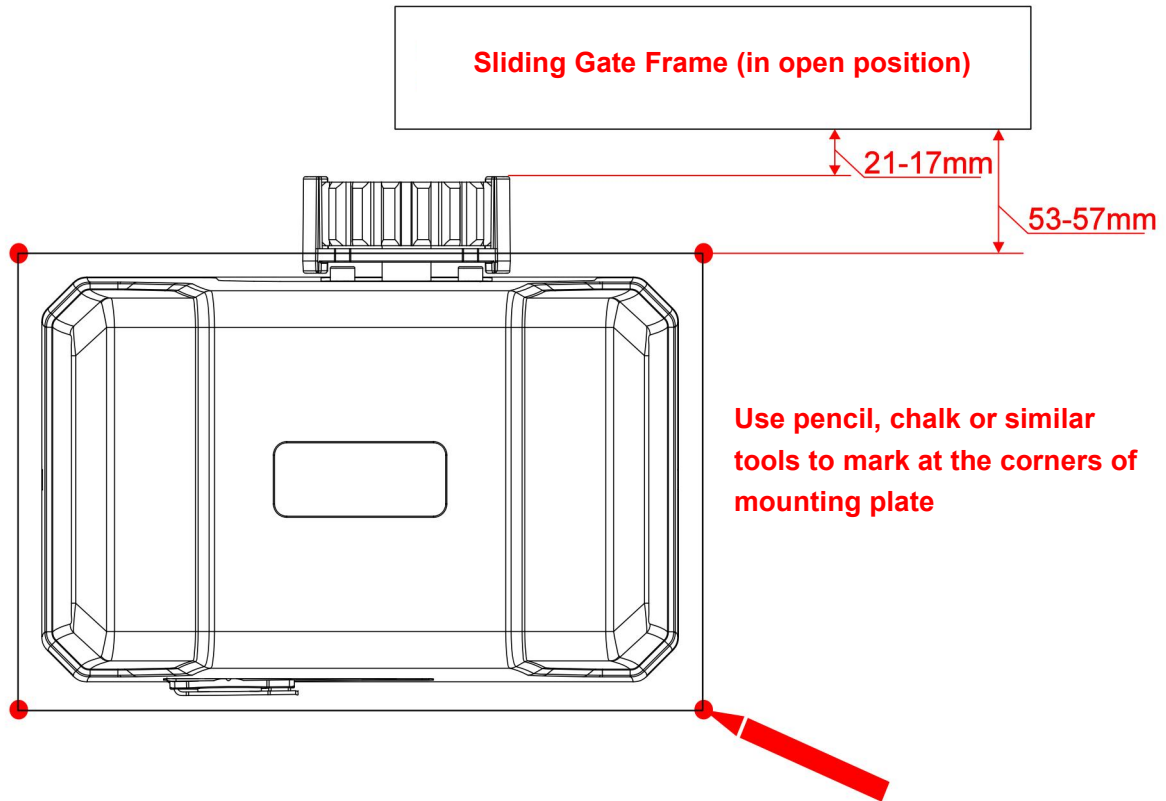

Figure 13

Step 6 - Gear Rack & Motor Alignment

- See Figure 15 for recommended gear rack mounting height.
- Ensure that the output gear has a minimum clearance of 1-2mm along the entire length of gear rack fitted to the gate (as per Figure 14)
- Ensure output gear and gear rack are correctly aligned. Under no circumstances should the gate opener output gear carry any weight of the gate. It is the task of the gate castors or wheels to carry the weight of the gate (as per Figure 14).
- If the gate doesn't slide freely by hand, adjust the height of the gear rack accordingly until the full length of gate slides freely by hand.

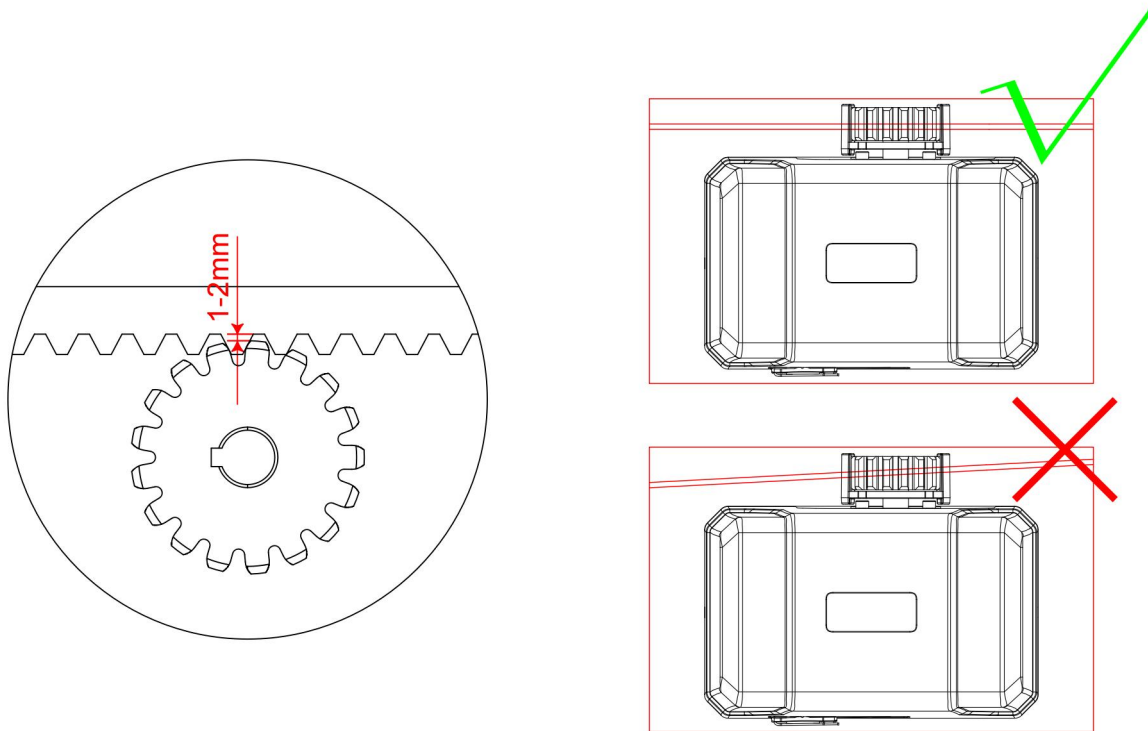

Figure 14

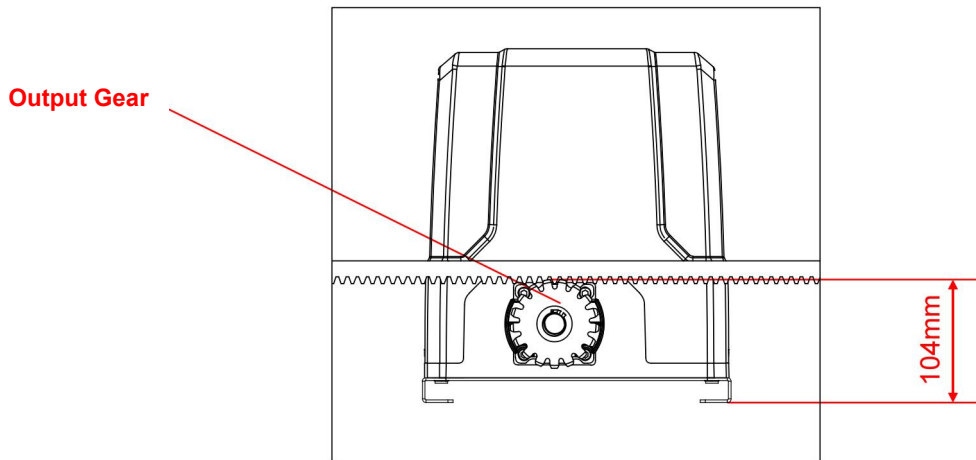
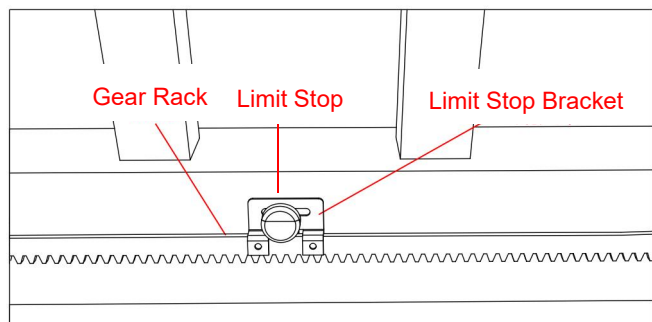

Figure 15

Step 7 - Limit Switch Stop

Included in your gate opener kit are two magnet limit switch stops with two different polarities: stop in black color(N), stop in blue color(S).

These two stops must be fitted to the gear racks on your gate to ensure safe operation. Before you fitting the limit switch stops, you



should install the limit switch stops on the stop brackets first. After fitting, please set on the control board to enable the gate into manual control mode(refer to page 19 “Manual Control Mode”), then operate the motor to run to its open or closed limit switch position to check if the limit switch can be well contacted.

It is extremely dangerous that bad contact between the limit switch and limit switch stops can cause crash of gate, damage of internal structure of the motor, moreover, the gate may slide off the guide rail.

The magnet limit switch stop is designed to recognize the gate running direction and it's current position. During gate moving, the magnetic limit switch which is installed inside the motor will detect the magnet limit switch stops when it passes, after detecting, the control board will record the gate running direction and the limit switch stop position to enable the gate run to the setting limit switch position.

To change the gate opener from right-hand installed to left-hand installed, you should only set it on the control board, no need to switch over the two magnet limit switch stops. So it's extremely important to decide the limit switch stops position and make sure the polarities are 100% correct.

Installation drawing of limit switch stop polarities for right-hand and left-hand:

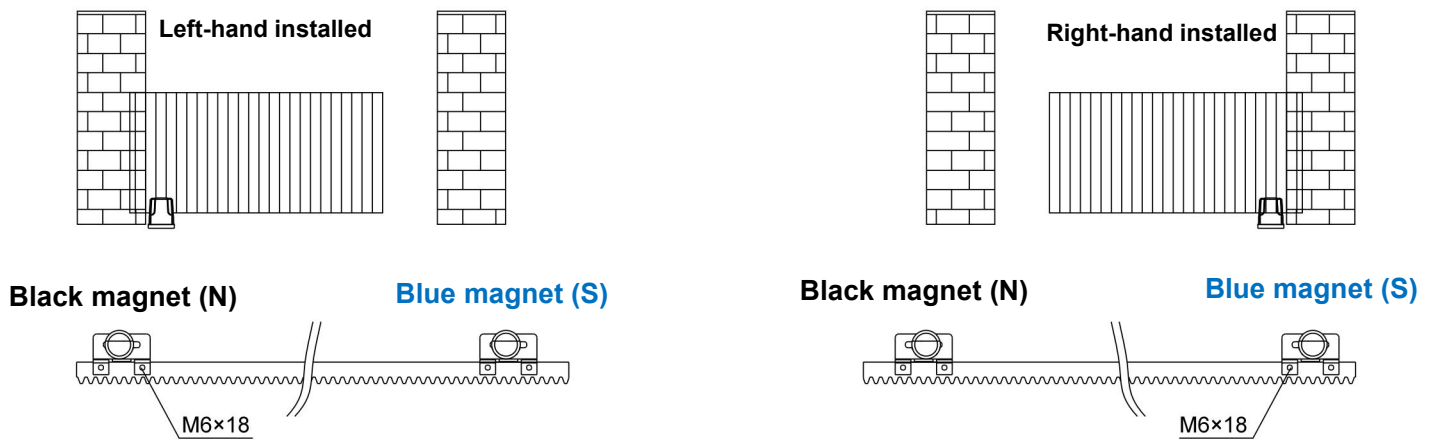

Figure 16

Note:

1. Default setting on control board is right-hand installed, if you need to change it to left-hand, please enter into advanced menu “opening direction setting” to change.
2. If you are not sure about the polarities of the two magnet limit switch stops are correct, please operate it on the control board to enter into manual control mode, and check if the gate will stop when it arrives at limit switch position.

Drawing of recommended installation height for the limit switch stop bracket:

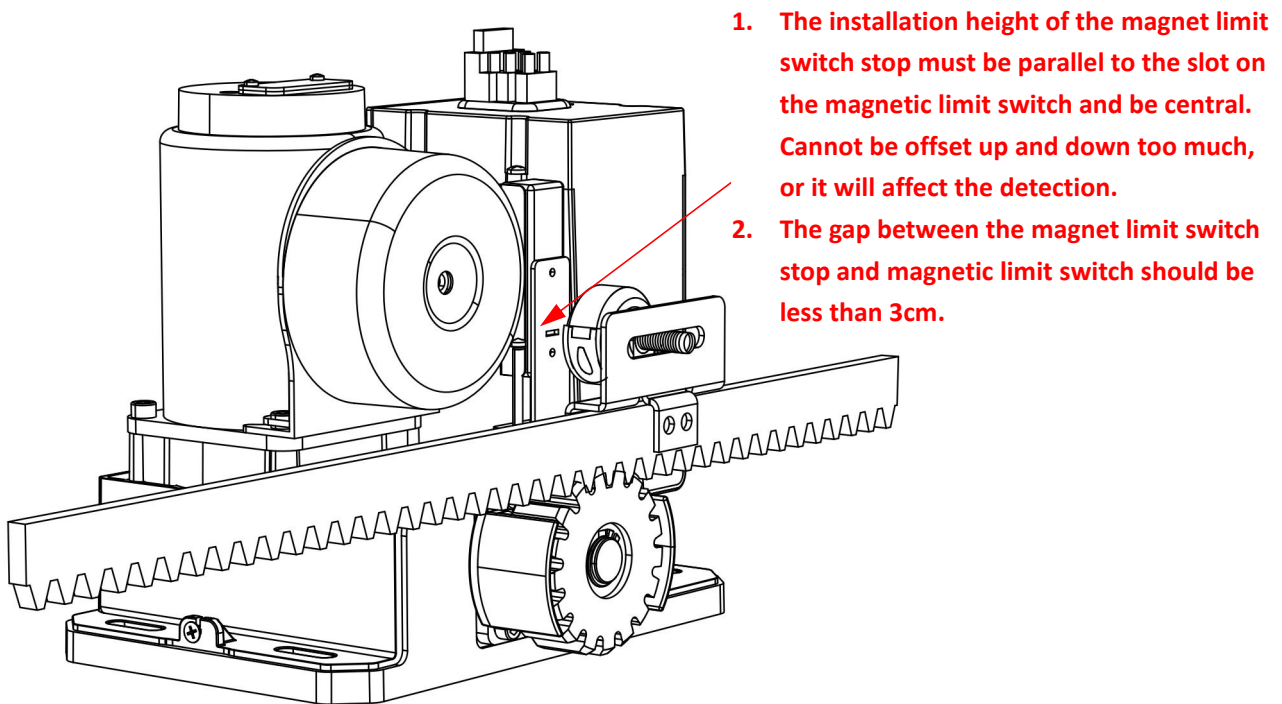

Figure 17

Step 8 - Powering on

- Ensure that the outer cover has been fitted and fastened back onto the motor base.
- Before powering up the gate opener make sure the gate can travel by hand in manual mode (key unlocked).
- Slide the gate to between the middle of the posts, approximately (see below diagrams).
- Lock the manual release spanner (key locked) in readiness for automatic mode.
- Plug the power cord into an approved RCD protected weatherproof outlet.
- Remote controls included in this kit are factory paired ready for use.

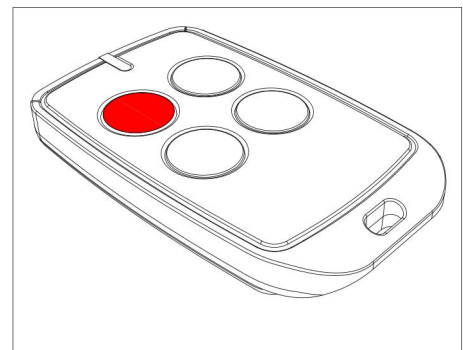
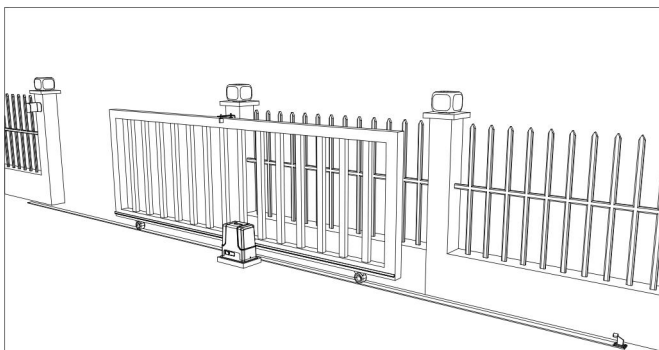

Figure 18

Step 9 - Testing Travel and Limit Stop Position

Ensure gate opener is installed as per step 4, 5 and 6 and the sliding gate is in the middle position. Limit switch stops are correctly installed and well contacted with magnetic limit switch. Please refer to page 20-21 for the setting of open and closed limit switch position.

The ideal closed final position for the gate frame is 10-15mm from closed gate end catch.

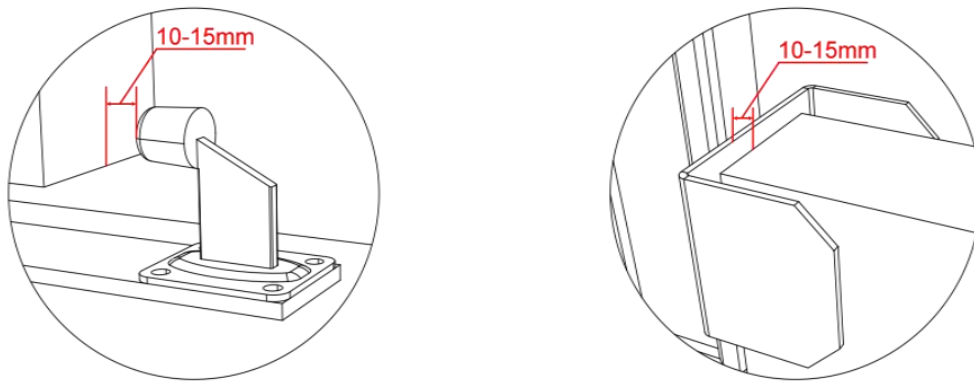

Figure 19

Now the basic open and closed positions are set, for further setting functions and adjusting parameters, please refer to pages 14-46 in this manual.

Programming and Wiring

Any works to the 110V/220V AC must only be performed by a licensed electrician.
 Ensure power is off before any modifications are made.

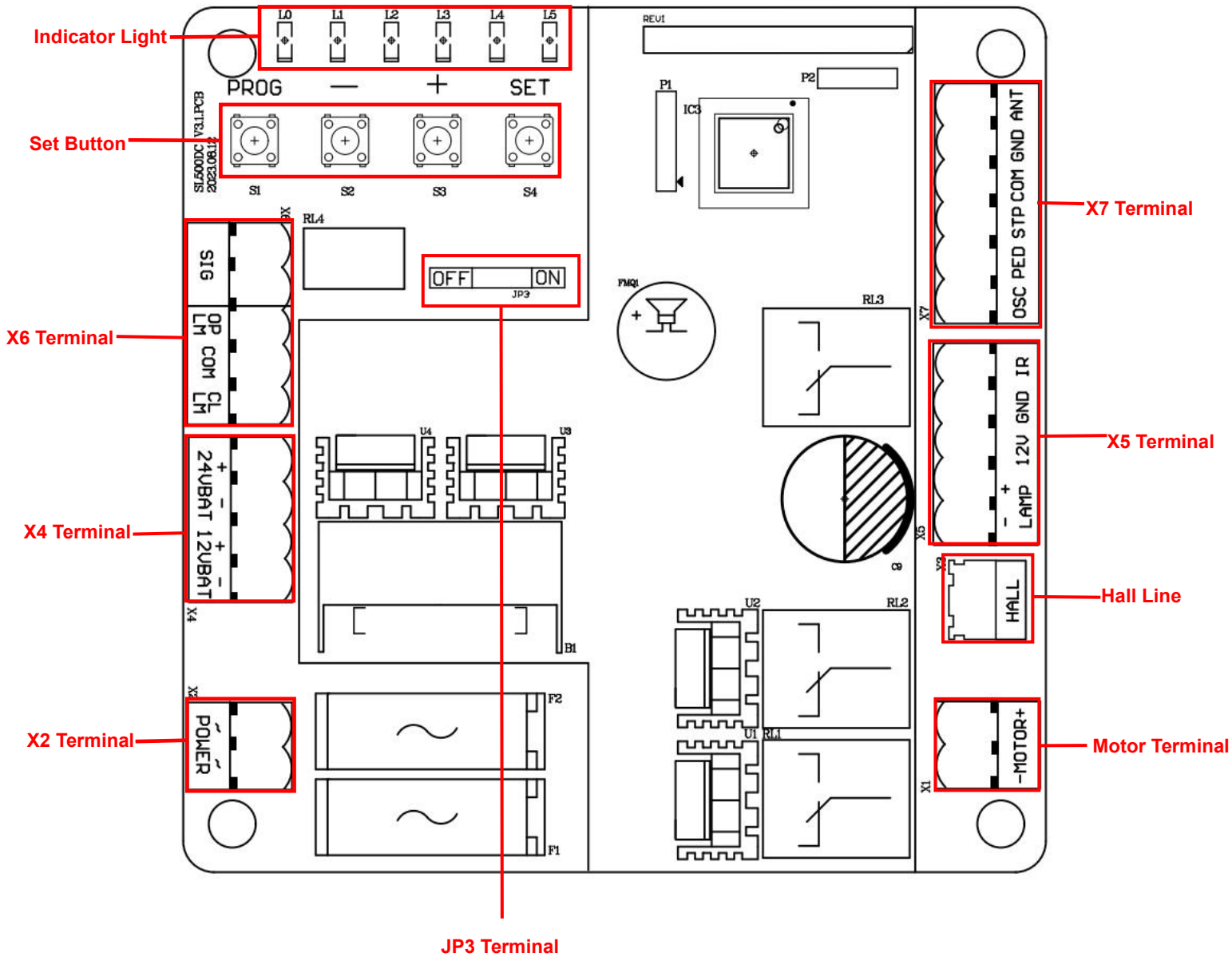

Figure 20

Terminal Instructions

All changes to these settings below must be completed by licensed electrician.



X7 Terminal: (as per Figure 20):

ANT: Extra Antenna

GND: Extra Antenna Shield

COM: Common Terminal for External Push Button

STP: External Stop Push Button Switch

PED: External Close Push Button Switch

OSC: External Open Push Button Switch

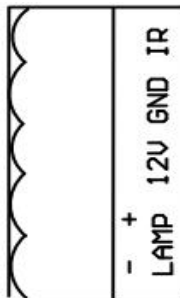

X5 Terminal:

IR: Photocell Input Common Terminal for Photocell(N.C.)

GND: Ground

12V: Additional Accessories +12VDC, after gate closed in place, the board will enter into low power consumption mode, this terminal will cut off the 12V power supply.

LAMP+: Alarm Lamp +12/24VDC

LAMP-: Alarm Lamp -12/24VDC

Wiring to the Terminal

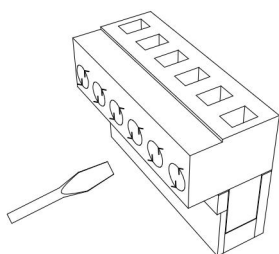

Using a screwdriver to loosen the screw on the side of the terminal.

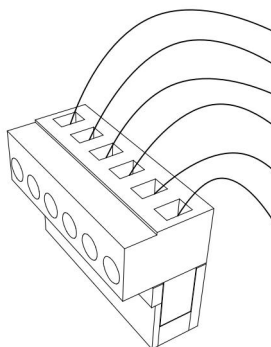

Insert the wire into the number on the terminal that you are looking to connect to.
Refer to Page 14.

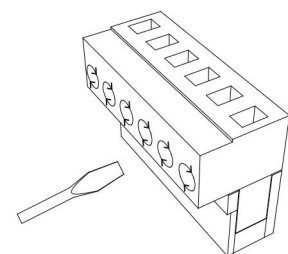

Tighten with a screwdriver to secure the wire in place.



JP3 Terminal:

Turn on the buzzer when the jumper cap is inserted into the ON end, and turn off the buzzer when the jumper cap is inserted into the OFF end.

Note:When the buzzer needs to be turned on, it is necessary to operate the control board to enter the "Other Menu" mode, turn on the buzzer function, and then plug the jumper cap into the ON end. At this time, the buzzer function can be used normally.

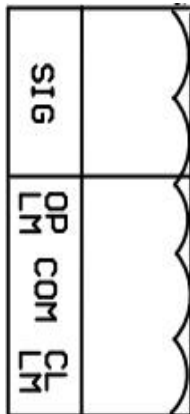

X6 Terminal:

SIG: Output close signal after gate closed in place.
OPLM: Open Limit Switch(Red Wire).
COM: Ground(White Wire).
CLLM: Close Limit Switch(Green Wire).

X4 Terminal:



24VBAT+: Battery Positive
24VBAT-: Battery Negative
 Battery Specification: 24V/9Ah

12VBAT+: Battery Positive
12VBAT-: Battery Negative
 Battery Specification: 12V/9Ah

Note: + and - must be wired correctly, wrong wiring will damage the control board.



X2 Terminal:

Power: Power Supply(Transformer Output)
 Transformer Specification: 240VAC/22VAC or 120VAC/22VAC
 Rated Power: 120W

Connecting Infrared Photocells

The below steps must be completed by licensed electrician.

Highly recommend the use of infrared photocells as an additional safety feature.

While closing, if the ray of the Infrared Photocell is blocked, the gate will stop and open immediately, to protect user and property security. To install photocells, connect wiring as per Figure 21. You must remove the wire jumper between terminal IR and terminal GND on X5 (ref to Figure 22).

The distance between photocell receiver and photocell transmitter should not be less than 2 meters; otherwise, the induction effect of photocell may be affected.

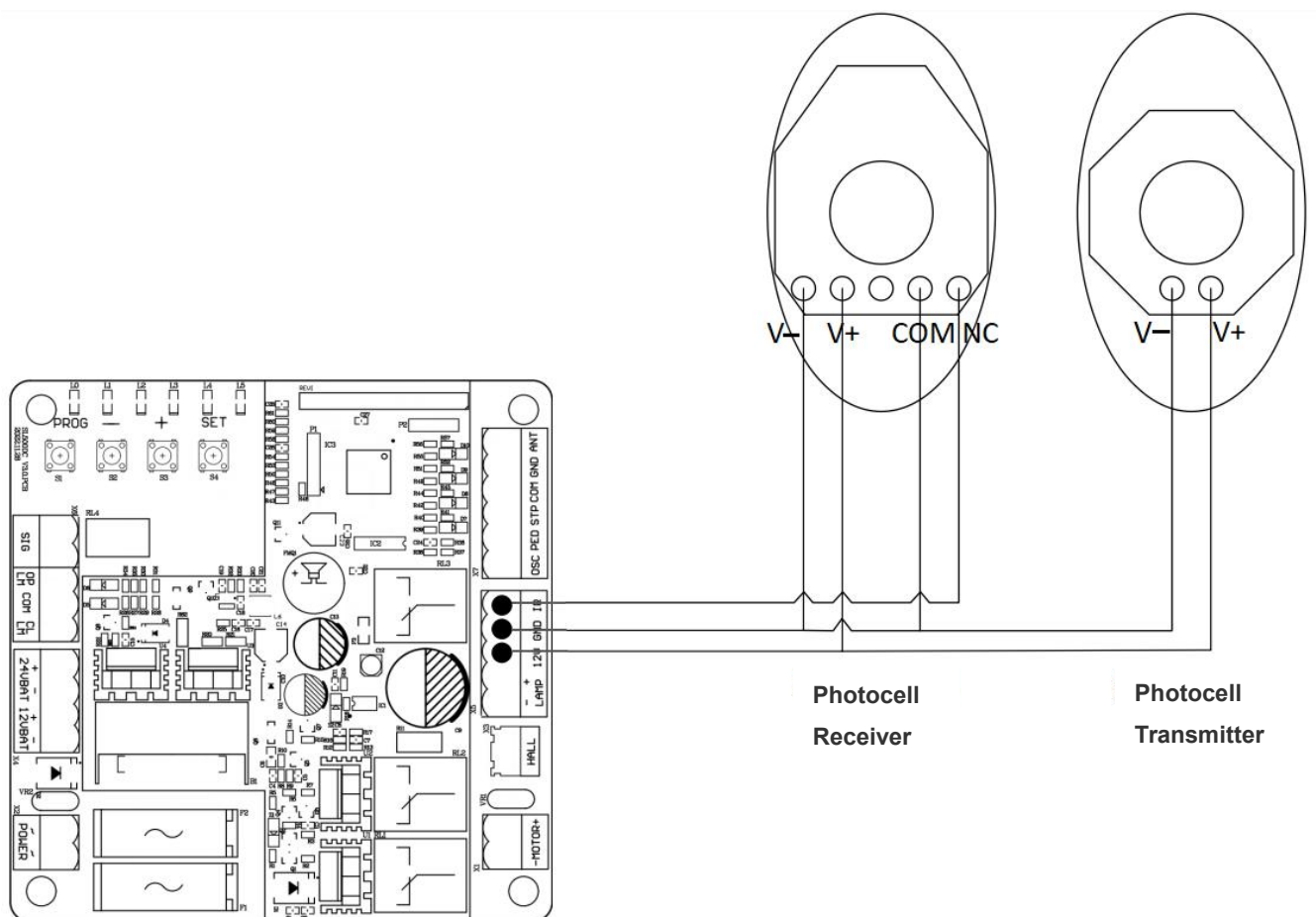
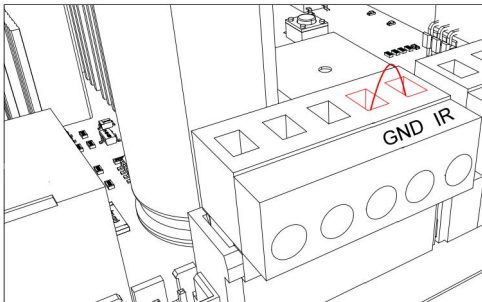
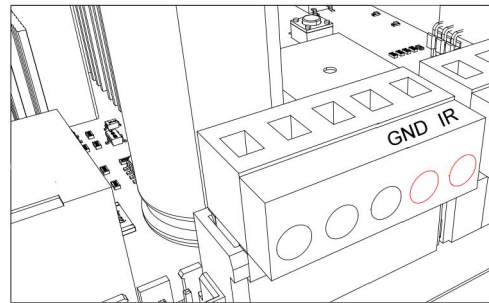

Figure 21

Before Installing Photocells



Power off, then loosen IR and GND ports on X5 Terminal with a screwdriver.



Remove the short circuit wire between ports IR & GND on X5 Terminal.

Figure 22

Operation Interface Instruction

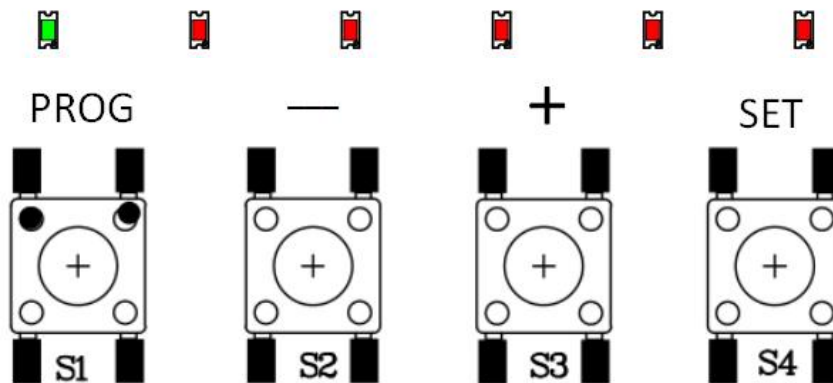

Figure 23

Indicator Lights:

L0 (Green): Indicating the control board working status and menu status.

L1-L5 (Red): Indicating the settings, parameters, errors and battery level.

Set Buttons:

PROG: Enter into or exit the setting menu.

- and +: Function select and parameter adjust.

SET: Choose the selection, confirm the setting.

Note:

Press the setting button for a short while (within 1 sec.) or long press the button (over 2 sec.) will be for different functions.

Manual Control Mode

In order to make sure that the first installation of this product is in good condition, users can test the opening/closing running under manual control mode. If there are any abnormalities, please exit the manual control mode and re-adjust the gate, gate opener and the limit switch.

A. Operation Instruction:

1. Press and hold "SET" button for 3 sec. → Indicator light L3 will flicker.
2. Press "+" button to open the gate, then release "+" to stop running; Press "-" to close the gate, then release it to stop running.
3. Press "PROG" button once to exit the manual control mode. → Indicator light L3 will be off.

B. Operation Graphic Illustration

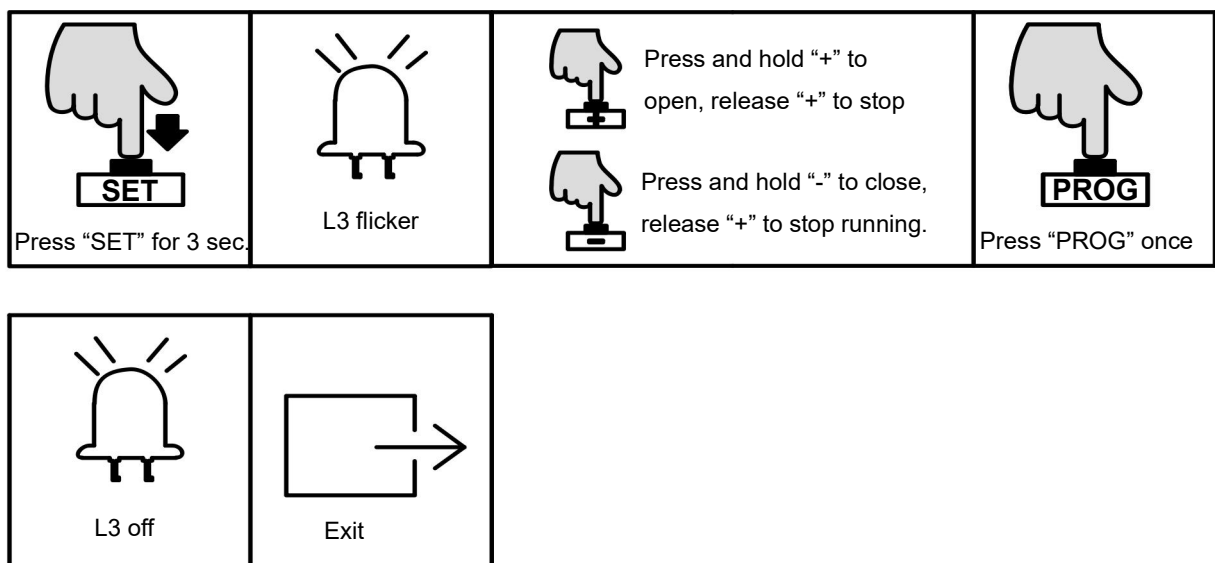

Note:

1. If there is no operation under the limit switch position setting for 60 sec., system will automatically exit the setting.
2. If need to exit during setting, press "PROG" once to directly exit.
3. Under manual control mode, if the gate didn't stop when it arrived at limit switch, please

exit the manual control mode, and check if the two magnet limit switch stops are within the detection range of the magnetic limit switch.

Quick Setting for Running Travel

Precondition:

1. Before setting the running travel, please make sure that the gate is completely open.
2. Please install the limit switch stops at limit switch position and make sure the polarities are correct, after installed, please do not move or remove it anymore.

A. Operation Instruction

- a. Press “+” button for 2 sec., motor will automatically start it’s travel learning.
- b. During gate closing, the indicator lights will be on from L5 to L1 in sequence and repeatedly.
- c. During gate opening, the indicator lights will be on from L1 to L5 in sequence and repeatedly.
- d. After travel is set, the indicator lights L1-L5 will be on in sequence, then all will flicker once and off.

B. Operation Graphic Illustration

1. Enter into Quick Setting:

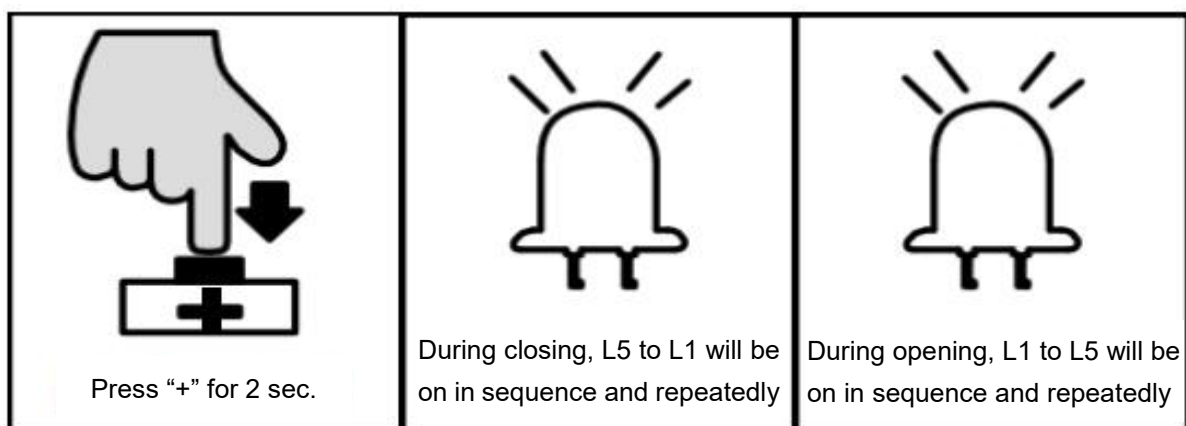

2. After Travel is Set:

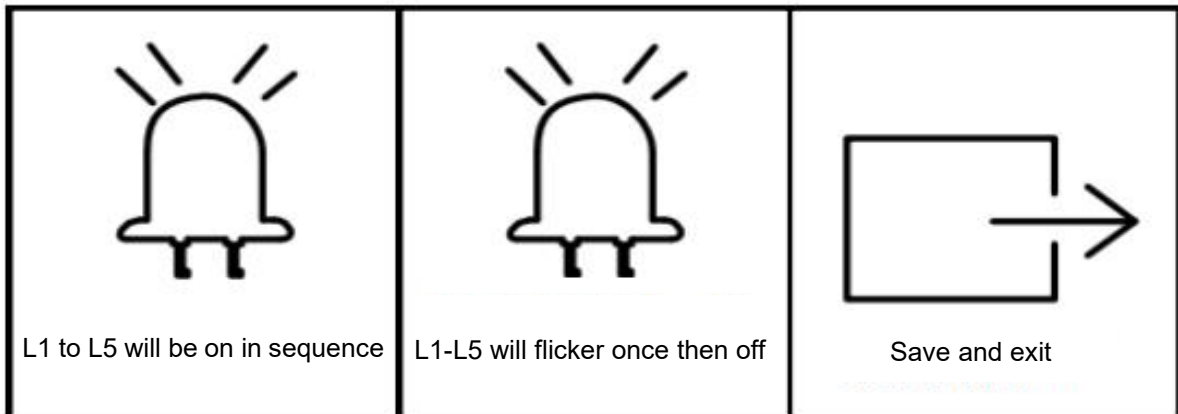

Note:

1. If there is no operation under the limit switch position setting for 60 sec., system will automatically exit the setting.
2. If need to exit during setting, press “PROG” once to exit.

Remote Control Management

Operation Instruction:

1. Press “-” button for 2 sec. under standby mode to enter into the first function of remote control management.
2. Different functions can be selected through “+” and “-” buttons.
3. Press “SET” button to enter into the corresponding parameter settings.

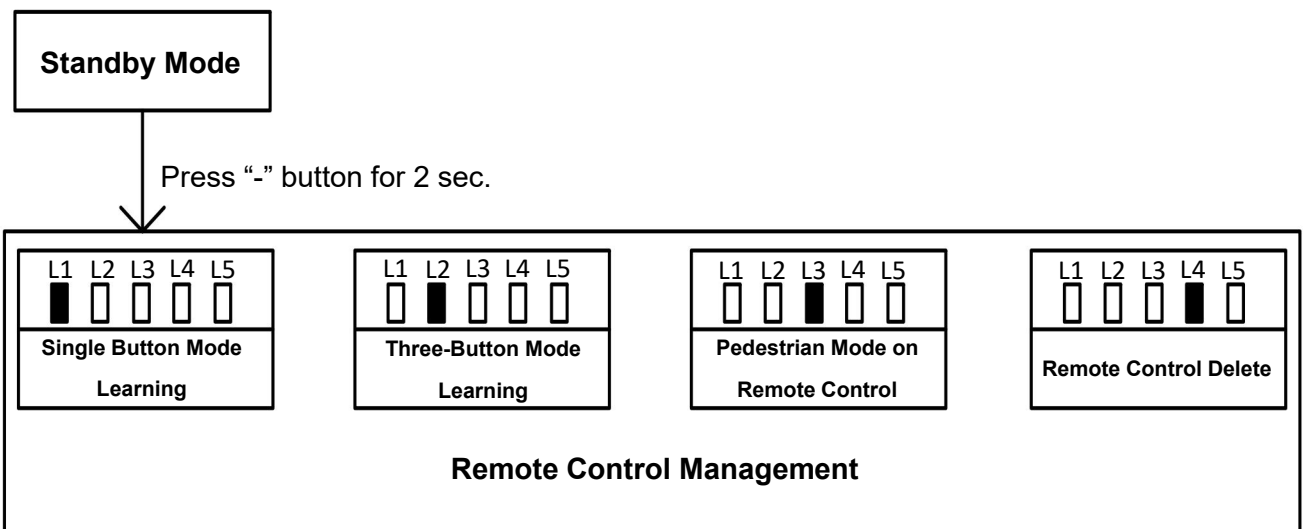

Figure 24

Remote Control Mode Instruction:

There are two modes available for remote control under this control board. Users may pair the remote control in their required mode.

1. Single button mode: Open/Stop/Close of the gate opener is controlled by only one button on the remote control.
2. Three button mode: Open/Stop/Close of the gate opener is controlled by three different buttons on the remote control.

Single Button Mode Learning (L1)

Under this mode, one of the remote control buttons which is paired to the gate opener can individually control the operation of one opener. The rest buttons on this remote control can be used to pair to other openers.

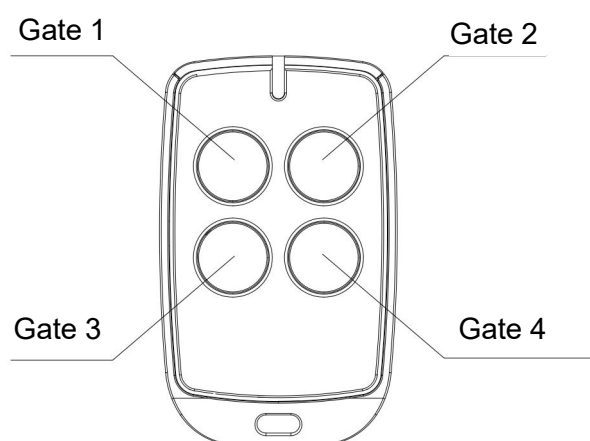
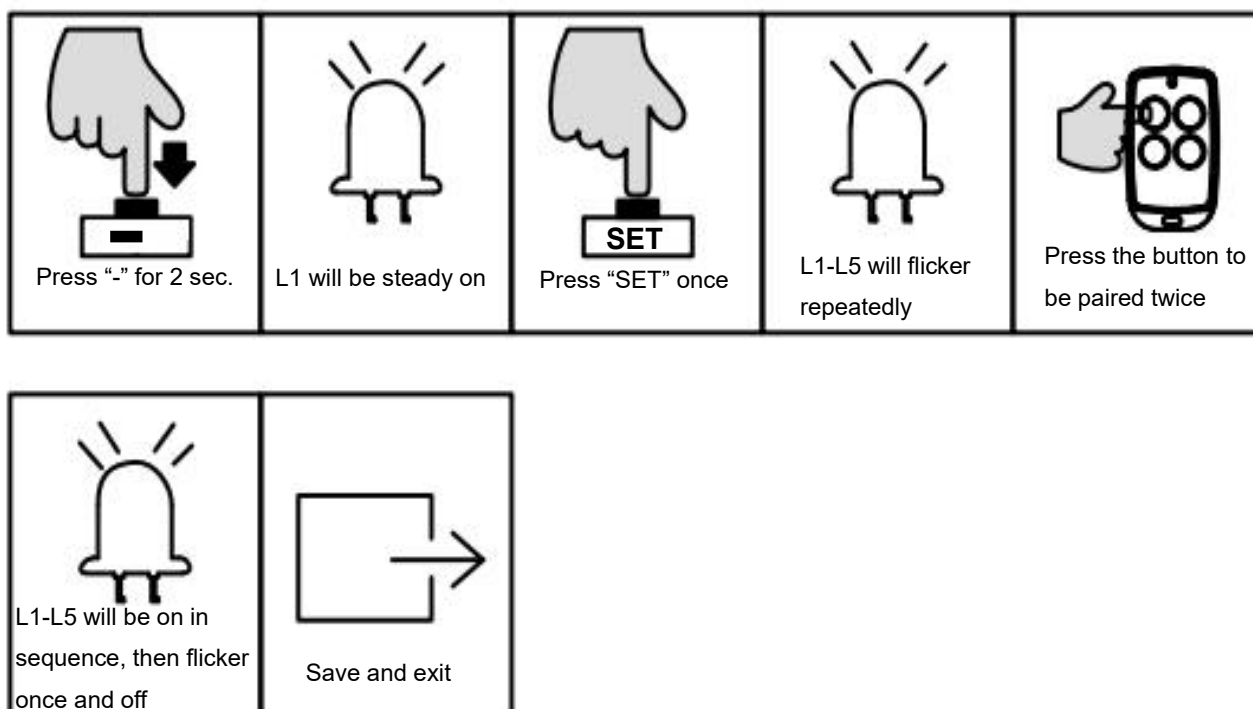

Figure 25

A. Operation Instruction

1. Press and hold “-” button for 2 sec. to enter into remote control management mode. → Indicator light L1 will be steady on.
2. Press “SET” button once to enter into single button learning mode. → All indicator lights will flicker repeatedly from L1 to L5. (If an alarm lamp is connected, it'll blink as well).
3. Press the button which is to be paired on the remote control twice. → The indicator lights L1-L5 will be on in sequence, then all will flicker once and off. (If an alarm lamp is connected, it'll be on for one sec.). Learning is complete thereafter.

B. Operation Graphic Illustration



Three-button Mode Learning (L2)

Under this mode, all buttons on the remote control which are paired to the gate opener will be separately used for gate opening、 closing and stop. (Please refer to Figure 26 for the usage for the forth button on the remote control)

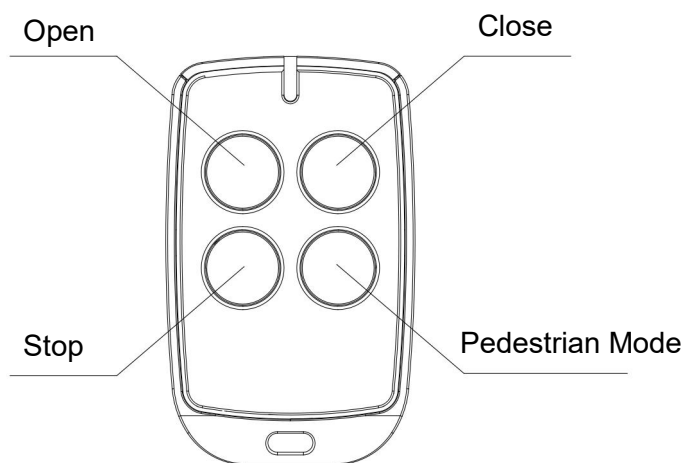
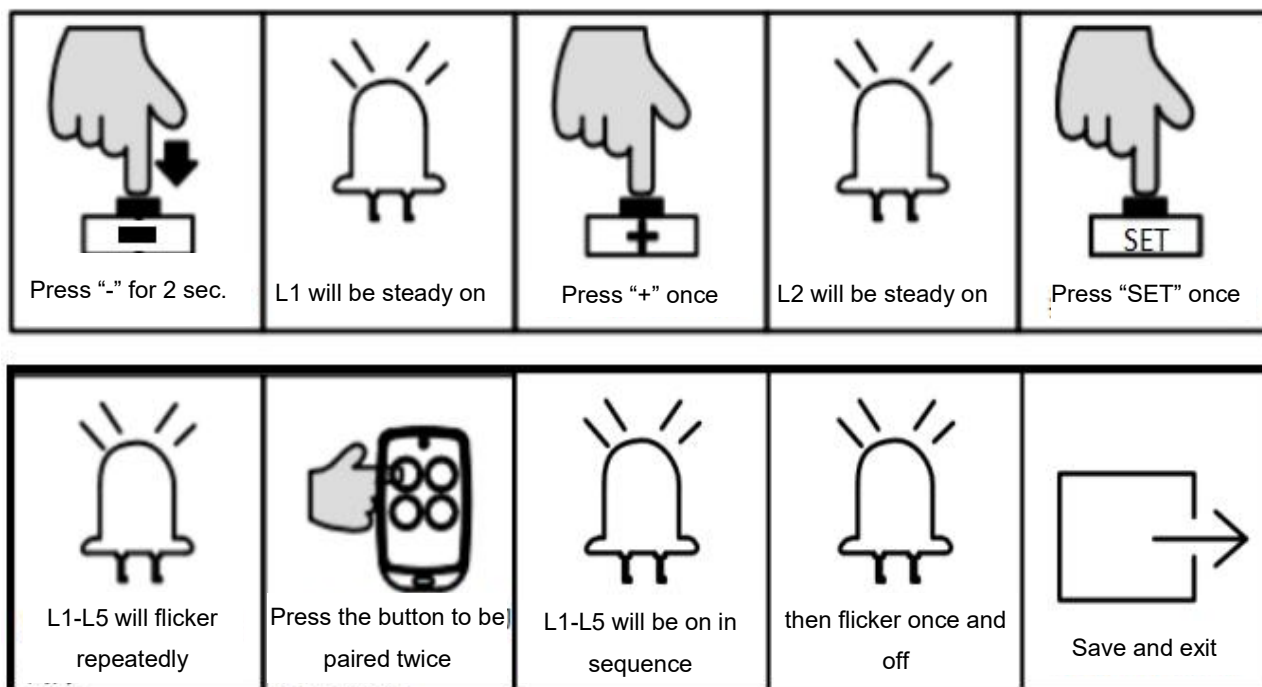

Figure 26

A. Operation Instruction

1. Press and hold “-” button for 2 sec. to enter into remote control management mode. → Indicator light L1 will be steady on.
2. Press “+” button once to select three button learning mode option. → Indicator light L2 will be steady on.
3. Press “SET” button once to enter into three button learning mode. → All indicator lights will flicker repeatedly from L1 to L5. (If an alarm lamp is connected, it’ll blink as well)
4. Press the button which is to be paired on the remote control twice. → The indicator lights L1-L5 will be on in sequence, then all will flicker once and off. (If an alarm lamp is connected, it’ll be on for one sec.) Learning is complete thereafter.

B. Operation Graphic Illustration



Note: If there is no operation under the remote control learning status for 20 sec., system will automatically exit the setting and save all the paired remote controls.

Pedestrian Mode on Remote Control (L3)

Pedestrian mode function: when gate is closed, press the Pedestrian button on the remote

control, the gate will open 1m wide to allow pedestrian access.

A. Operation Instruction:

1. Press and hold “-” button for 3 sec. to enter into remote control management mode. → Indicator light L1 will be steady on.
2. Press “+” button twice to select pedestrian mode function. → Indicator light L3 will be steady on.
3. Press “SET” button once to enter into pedestrian mode setting. → All indicator will flicker repeatedly from L1 to L5.
4. Press the button which is to be paired on the remote control once. → The indicator lights L1-L5 will be on in sequence, then all will flicker once and off.. Learning is complete thereafter.

B. Operation Graphic Illustration:

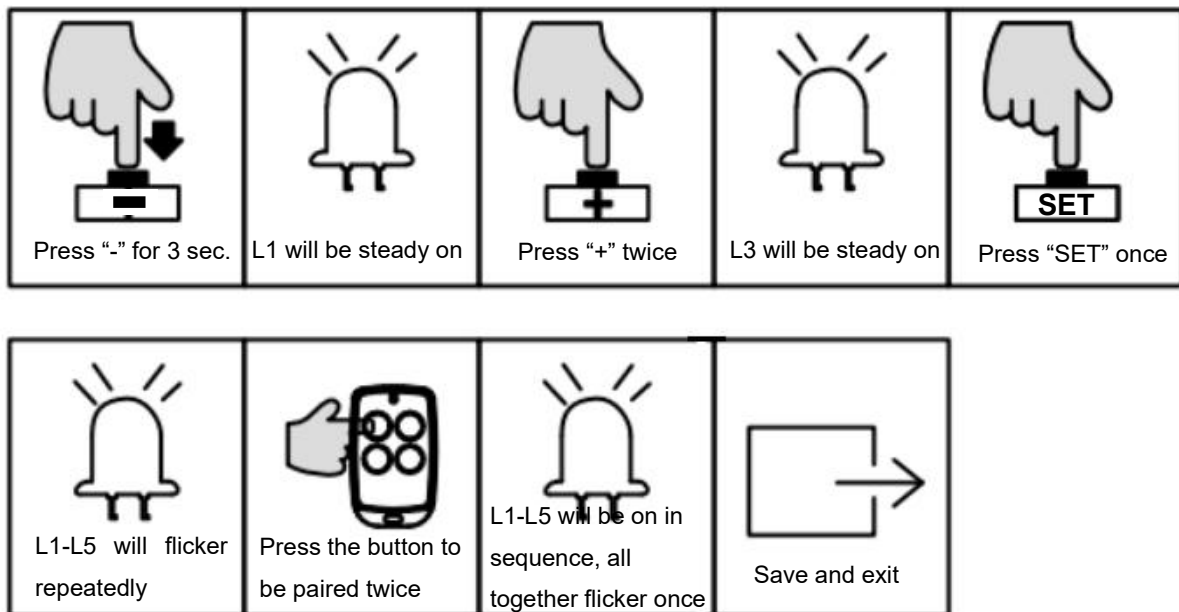

Remote Control Delete (L4)

This operation will delete all the remote controls that are paired to this control board.

A. Operation Instruction:

1. Press and hold “-” button for 2 sec. to enter into remote control management mode. →

- Indicator light L1 will be on.
2. Press "+" button three times to select remote control delete option. → Indicator light L4 will be on.
 3. Press "SET" button once to enter into remote control delete option. → Indicator lights L1-L5 will be steady on.
 4. Press and hold "SET" button for 2 sec. will delete all remotes and it will automatically exit. → Indicator lights will be off in sequence from L5 to L1, after which indicator lights L1-L5 will be on for one sec.

B. Operation Graphic Illustration:

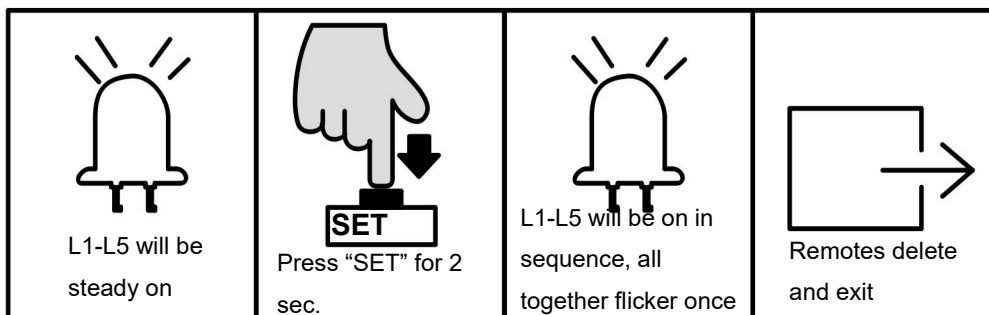
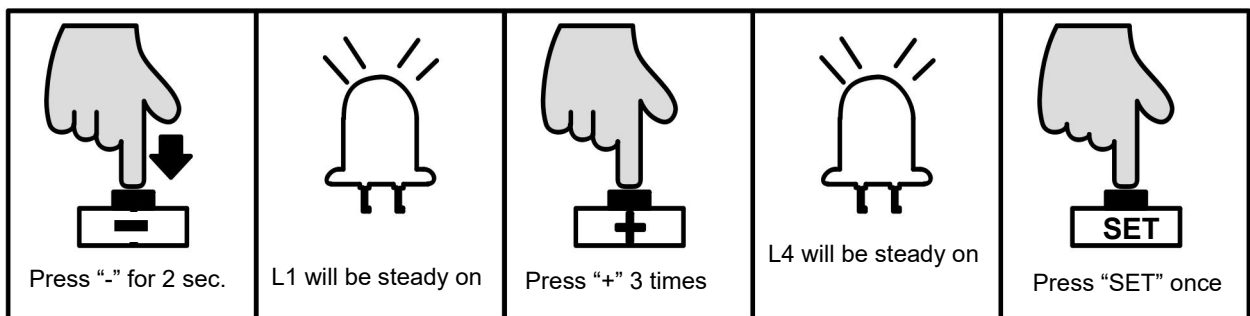

Remote Control Quick Learning

Remote control quick learning function enables user to pair the remote controls without opening the motor cover.

Precondition:

1. To have one remote control that has already been paired.

2. To ensure the reliability of learning, please operate the quick learning function within 2 meters from the gate opener.
3. Please make sure that the gate opener is equipped with an alarm lamp, which will help you to check the status of remote control learning.

A. Operation Instruction:

1. Simultaneously press and hold the third and the fourth buttons of the paired remote control for 6 sec. → The alarm lamp will flash, which indicates that the learning function of the control board is on working.
2. Press the button to be learned on the remote control under the above status. → The alarm lamp will be off. Then remote control learning is complete.
3. The system will automatically exit the learning mode after pairing finished.

Note: The remote control working mode will be copied from original one to new paired one.

B. Operation Graphic Illustration:

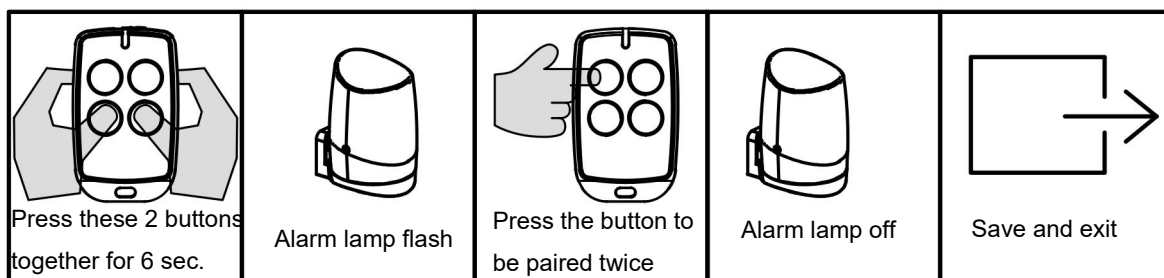

Basic Menu Setting

Operation Instruction:

1. Under standby mode, press and hold “PROG” button for 3 sec., the indicator light L0 will flicker once and enter into basic menu setting.
2. Press “+” or “-” button to select the different function settings.
3. Press “SET” button to enter into the selected function setting.

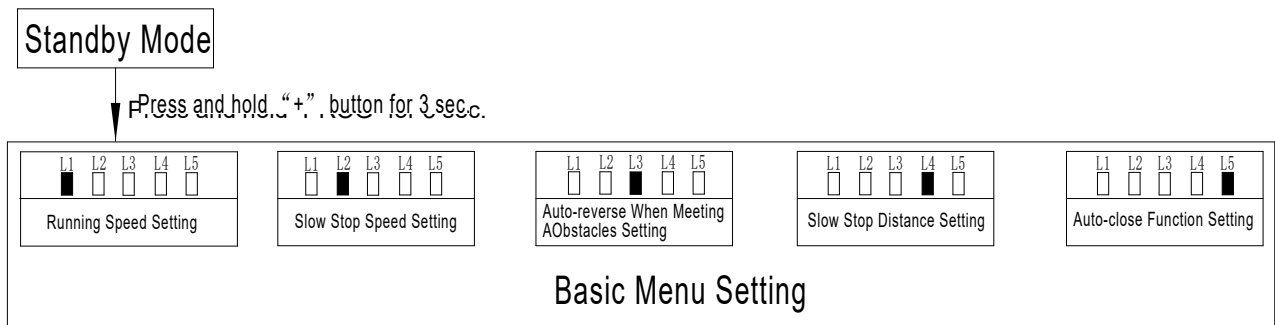

Figure 27

Running Speed Setting (L1)

Users can adjust the gate opening and closing speed according to the actual installation and using condition.

A. Operation Instruction:

1. Press and hold “PROG” button for 3 sec. to enter into basic menu. → Indicator light L0 will flicker once, then L1 will be steady on.
2. Press “SET” button once to enter into running speed setting. → Indicator lights L1-L5 will show the current running speed. (The default is L5)
3. Press “+” or “-” button to adjust the running speed. → Indicator lights L1-L5 will indicate different speed status. The more the indicator lights are on, the faster the running speed will be.
4. Press “SET” button to save and system will automatically exit. → The indicator lights L1-L5 will be on in sequence, then all will flicker once and off.

B. Operation Graphic Illustration

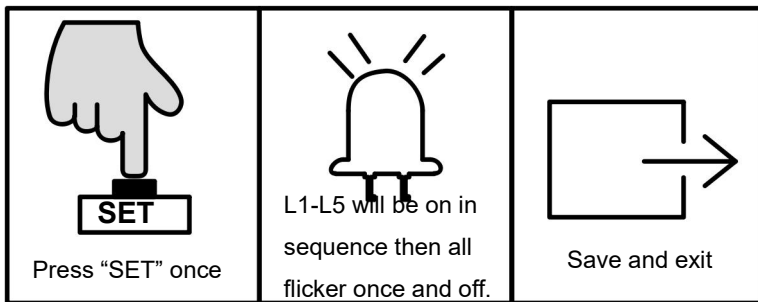
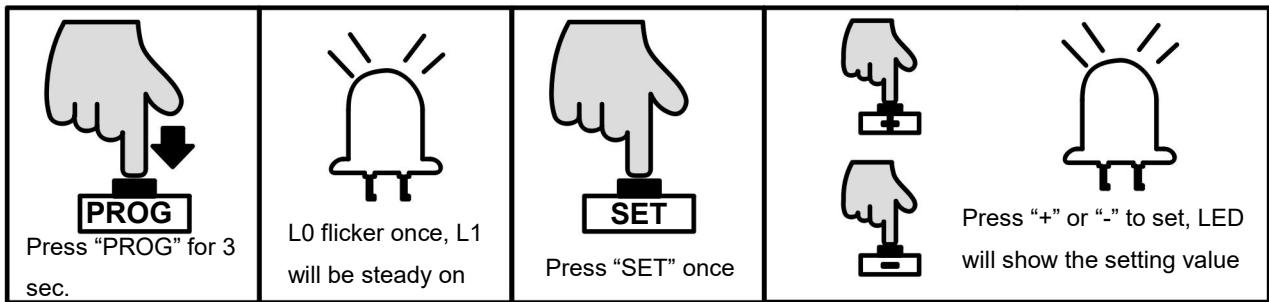

Slow Stop Speed Setting (L2)

The setting for slow stop speed can effectively reduce the inertial force when the gate is open or closed to its limit position, which will extend the lifetime of both gate and gate opener.

A. Operation Instruction:

1. Press and hold "PROG" button for 3 sec. to enter into basic menu. → Indicator light L0 will flicker once, then L1 will be steady on.
2. Press "+" button to select slow stop speed setting. → Indicator light L2 will be steady on.
3. Press "SET" button once to enter into setting mode. → Indicator lights L1-L5 will show the current slow stop speed. (The default is L2)
4. Press "+" or "-" button to adjust the slow stop speed. → Indicator lights L1-L5 will show the different speed status. The more the indicator lights are on, the faster the slow stop speed will be.
5. Press "SET" button to save and system will automatically exit. → The indicator lights L1-L5 will be on in sequence, then all will flicker once and off.

B. Operation Graphic Illustration

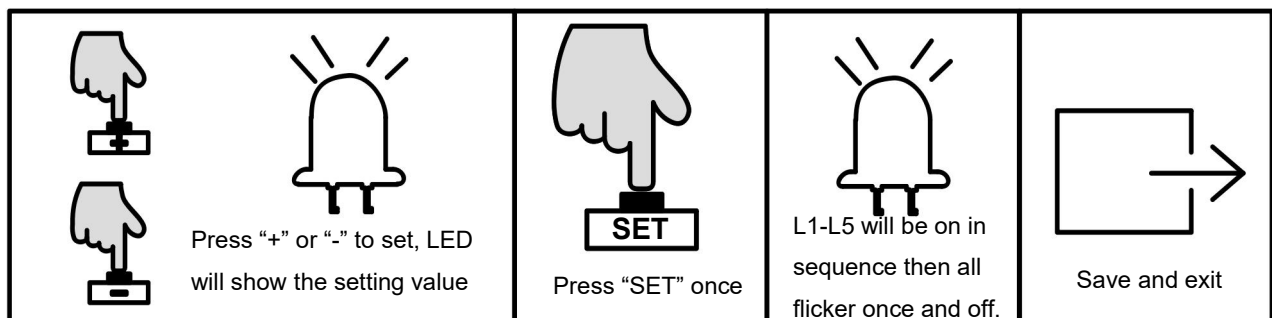
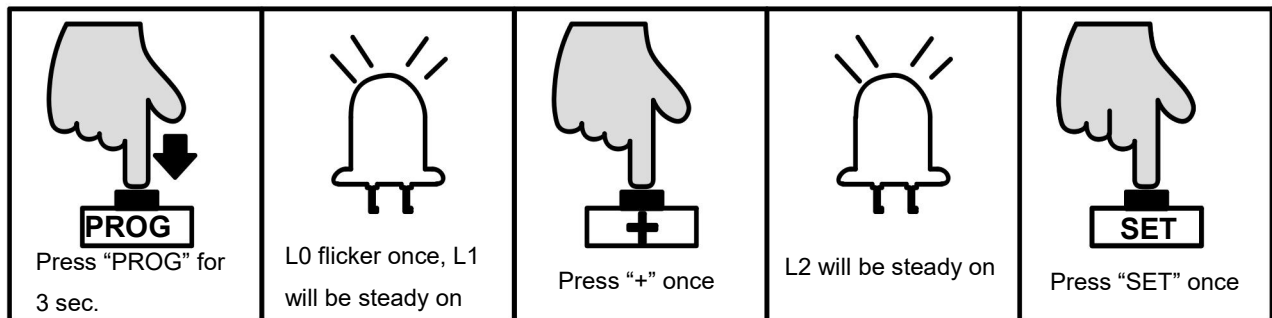

Reverse When Meeting Obstacles Setting (L3)

During the gate opening or closing, accidental collision with obstacles may pose a threat to people and property. In order to prevent impact of such collision, users may adjust the sensitivity of meeting obstacles to reduce the impact damage.

A. Operation Instruction:

1. Press "PROG" button for 3 sec. to enter into basic menu. → Indicator light L0 will flicker once, then L1 will be steady on.
2. Press "+" button twice to select the reverse option. → Indicator light L3 will be steady on.
3. Press "SET" button once to enter into setting mode. → Indicator lights L1-L5 will show the current setting. (The default is L3)
4. Press "+" or "-" button to set the sensitivity of meeting obstacles. → Indicator lights L1-L5 will show the different sensitivity of meeting obstacles. The less the indicator lights are on, the more the sensitivity will be. L1-L5 are all off means to cancel the Auto-reverse function.

5. Press “SET” button once to save the setting and system will automatically exit. → The indicator lights L1-L5 will be on in sequence, then all will flicker once and off.

B. Operation Graphic Illustration

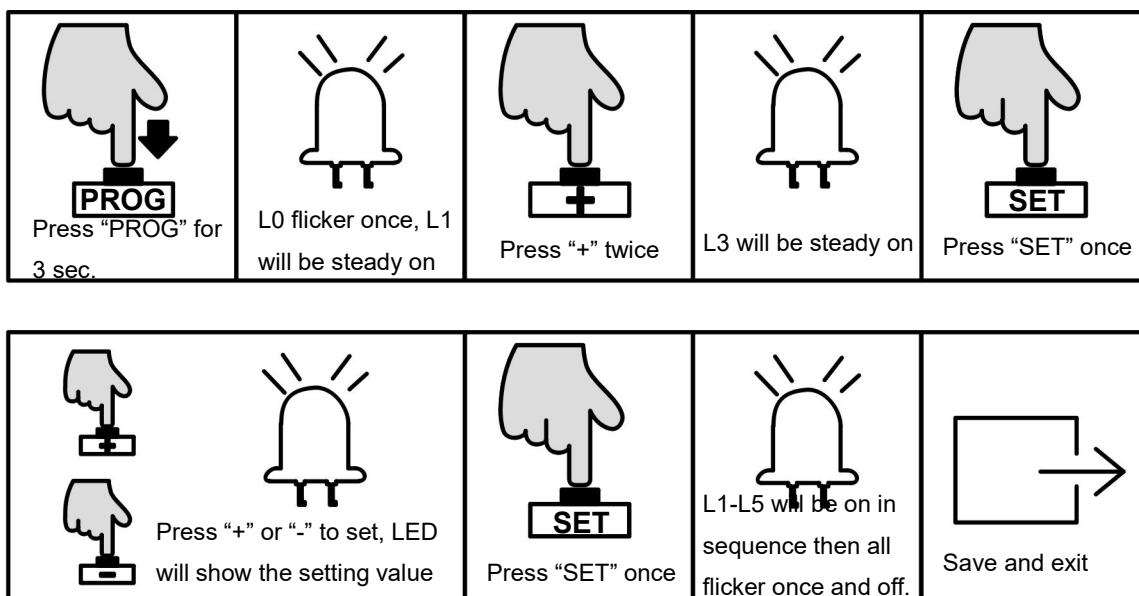

Note: The default setting of this function is suitable for gate weighting 500kg and the glide rail for running the gate is smooth, if this function is not workable or reverse frequently, please adjust the settings to reduce or increase a little bit.

Slow Stop Distance Setting (L4)

Setting a slow stop distance enables the gate to run more smoothly, which will extend the service life of gate and gate opener.

A. Operation Instruction:

1. Press and hold “PROG” button for 3 sec. to enter into basic menu. → Indicator light L0 will flicker once, then L1 will be steady on.
2. Press “+” button three times to select slow stop distance option. → Indicator light L4 will be steady on.
3. Press “SET” button once to enter into slow stop distance setting. → Indicator lights L1-L5 will show the current distance of slow stop. (The default is L3)
4. Press “+” or “-” button to set the slow stop distance. → Indicator lights L1-L5 will show

the different slow stop distance. The more the indicator lights are on, the longer the distance will be. If the gate is heavy(over 800kg), it is recommended to set it on L4 or L5 to have a better slow stop running. If the gate weight is less than 500kg, it is recommended to set it on L2 or L1 to have a better slow stop running.

5. Press “SET” button once to save and system will automatically exit. → The indicator lights L1-L5 will be on in sequence, then all will flicker once and off.

B. Operation Graphic Illustration

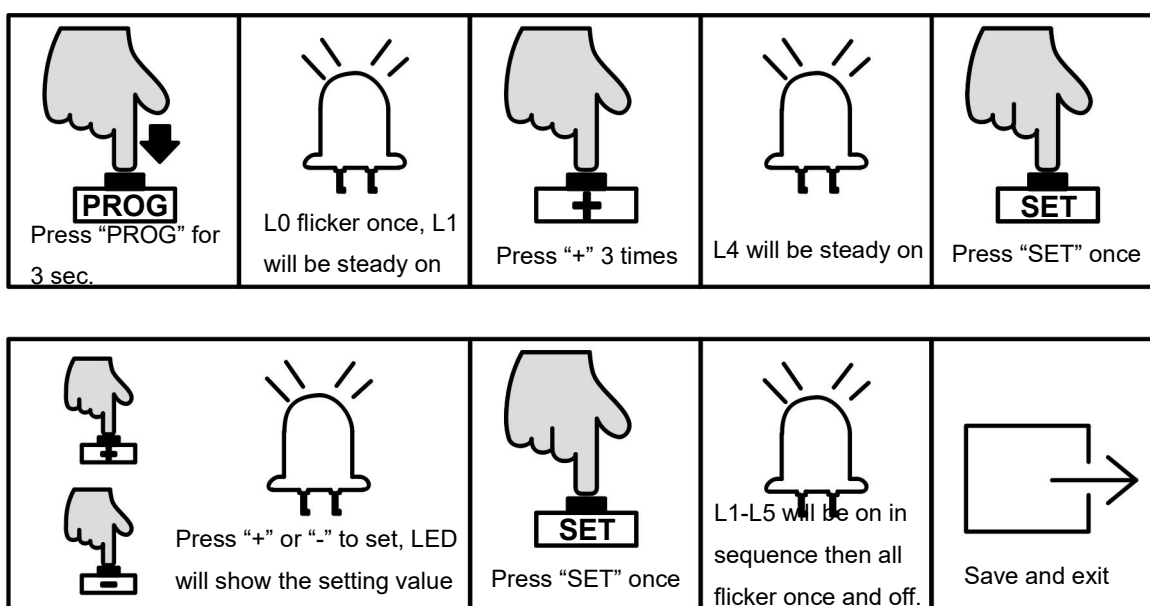

Auto-close Function Setting (L5)

When the gate is completely open, the control board will send the auto-close signal to enable the gate to close automatically according to the pre-set auto-close time.

A. Operation Instruction:

1. Press and hold “PROG” button for 3 sec. to enter into basic menu. → Indicator light L0 will flicker once, then L1 will be steady on.
2. Press “+” button four times to enter into Auto-close option. → Indicator light L5 will be steady on.
3. Press “SET” button once to enter into setting. → Indicator lights L1-L5 will show the current auto-close time. (The default is all indicator lights off)

4. Press “+” or “-” button to set the auto-close time. → The number of steady on indicator lights will indicate the Auto-close time. (Table 1 Auto-Close Time)
5. Press “SET” button once to save and system will automatically exit. → The indicator lights L1-L5 will be on in sequence, then all will flicker once and off.

B. Operation Graphic Illustration

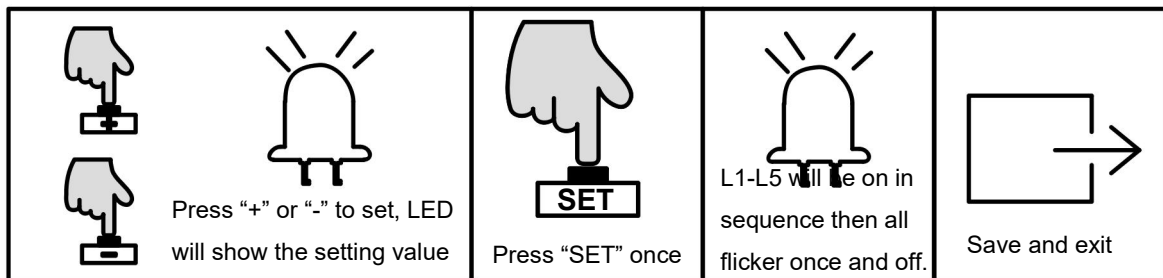
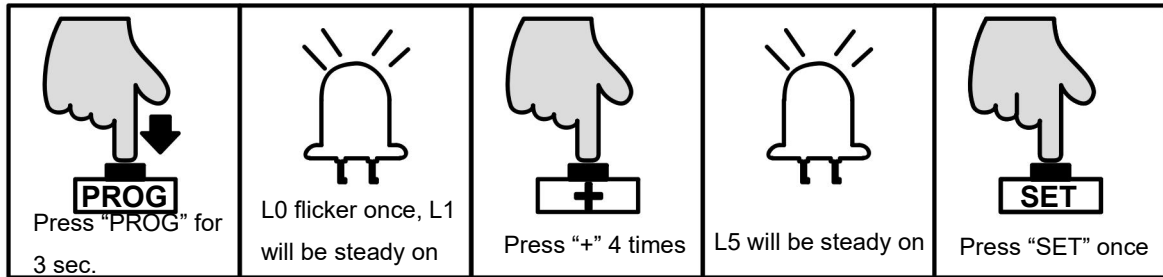

Indicator light status: <input type="checkbox"/> Off <input checked="" type="checkbox"/> On <input type="checkbox"/> Flicker	Status Instruction
L1 <input type="checkbox"/> L2 <input type="checkbox"/> L3 <input type="checkbox"/> L4 <input type="checkbox"/> L5 <input type="checkbox"/>	Cancel Auto-close function
L1 <input checked="" type="checkbox"/> L2 <input type="checkbox"/> L3 <input type="checkbox"/> L4 <input type="checkbox"/> L5 <input type="checkbox"/>	Auto-close after 10 sec.
L1 <input checked="" type="checkbox"/> L2 <input checked="" type="checkbox"/> L3 <input type="checkbox"/> L4 <input type="checkbox"/> L5 <input type="checkbox"/>	Auto-close after 20 sec.
L1 <input checked="" type="checkbox"/> L2 <input checked="" type="checkbox"/> L3 <input checked="" type="checkbox"/> L4 <input type="checkbox"/> L5 <input type="checkbox"/>	Auto-close after 30 sec.
L1 <input checked="" type="checkbox"/> L2 <input checked="" type="checkbox"/> L3 <input checked="" type="checkbox"/> L4 <input checked="" type="checkbox"/> L5 <input type="checkbox"/>	Auto-close after 40 sec.
L1 <input checked="" type="checkbox"/> L2 <input checked="" type="checkbox"/> L3 <input checked="" type="checkbox"/> L4 <input checked="" type="checkbox"/> L5 <input checked="" type="checkbox"/>	Auto-close after 50 sec.

Table 1 Auto-Close Time

Advanced Menu Setting

1. Press “PROG” button for 3 Sec. under the standby mode, indicator light L0 will flicker once to enter into basic menu setting. Press “PROG” button again for 3 sec. indicator light L0 will flicker twice to enter into the advanced menu setting.
2. Different functions can be selected through “+” and “-” buttons.
3. Press “SET” button to enter into the selected function settings

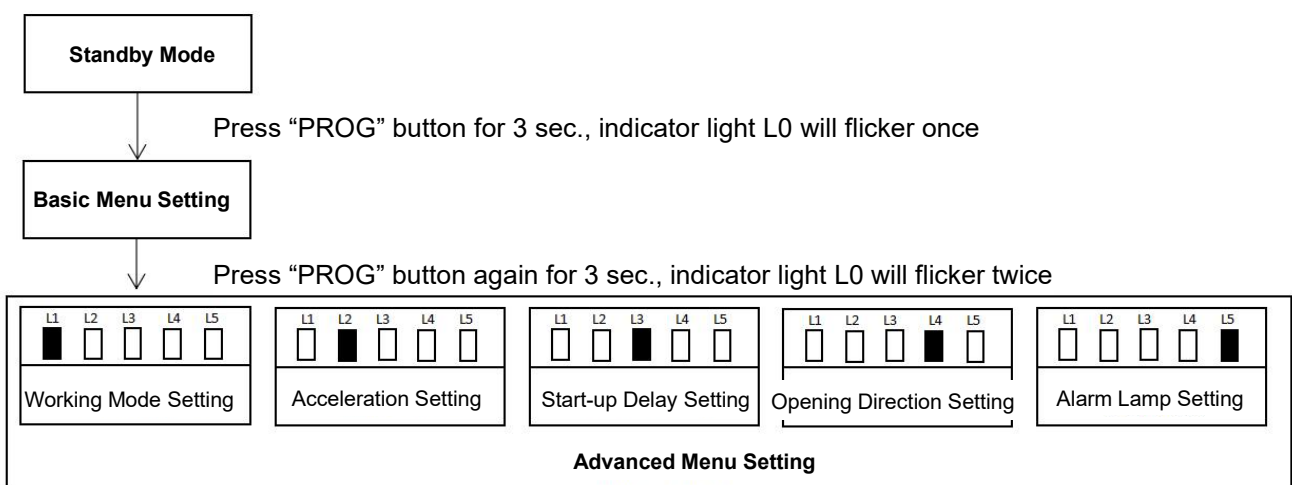

Figure 28

Working Mode Setting (L1)

Due to the usage for this product is different for users from different regions, the control board for this product offers 3 different working modes for users to choose.

1. Standard Mode (L1):

Terminals for external buttons:

OSC: Single button control PED: Pedestrian button STP: Stop button

2. Three Button Mode (L2):

Terminals for external buttons:

OSC: Opening button PED: Closing button STP: Stop button

3. Community Mode (L3):

Terminals for external buttons:

OSC: Single button control PED: Pedestrian button STP: Stop button

Special function: Only the gate is completely open, can it be closed thereafter. If the gate is not completely open, then only opening and stop can be operated in order to prevent any interruption which will trigger closing during the opening travel operated by the first user.

A. Operation Instruction:

1. Press and hold “PROG” button for 3 sec. to enter into basic menu. → Indicator light L0 will flicker once, then L1 will be steady on.
2. Press “PROG” button again for 3 sec. to enter into advanced menu. → Indicator light L0 will flicker twice, then L1 will be steady on.
3. Press “SET” button once to enter into working mode setting. → Indicator lights L1-L3 will show the current selection. (The default is L1)
4. Press “+” or “-” button to select the working mode. → Indicator lights L1-L3 will show the current selection.
5. Press” SET” button once to save and system will automatically exit. → The indicator lights L1-L5 will be on in sequence, then all will flicker once and off.

B. Operation Graphic Illustration

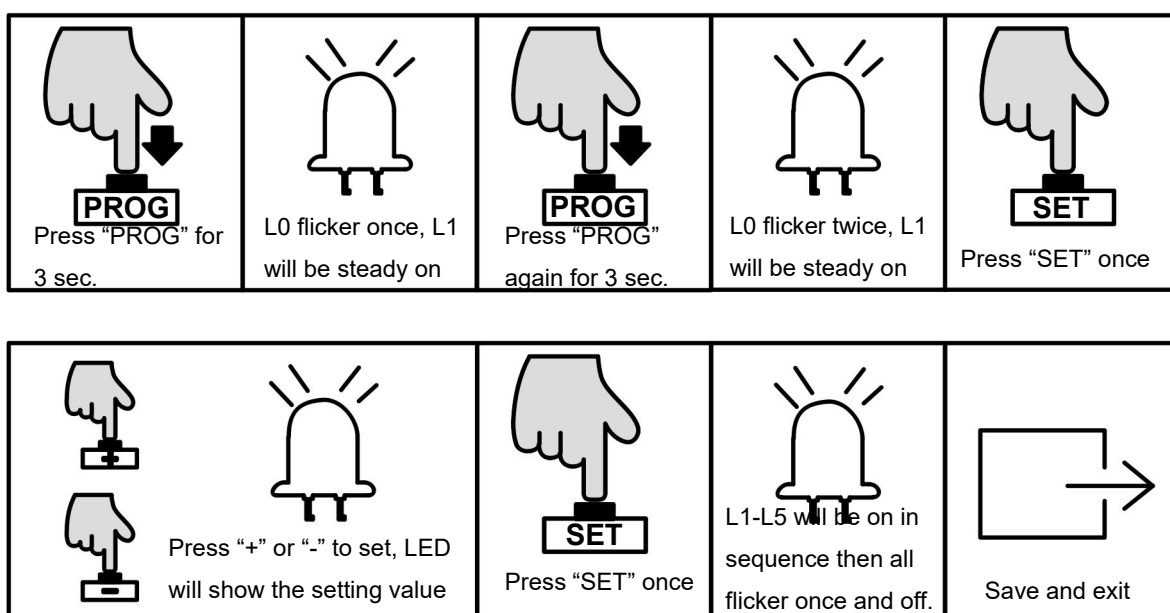

Acceleration Setting (L2)

Due to the different installation environment and gate installation status, users can adjust the acceleration of starting and deceleration of buffering of the gate opener to their necessary.

A. Operation Instruction:

1. Press and hold “PROG” button for 3 sec. to enter into basic menu. → Indicator light L0 will flicker once, then L1 will be steady on.
2. Press “PROG” button again for 3 sec. to enter into advanced menu. → Indicator light L0 will flicker twice, then L1 will be steady on.
3. Press “+” button once to select acceleration option. → Indicator light L2 will be steady on.
4. Press “SET” button once to enter into acceleration setting. → Indicator lights L1-L5 will show the current acceleration value. (The default is L2)
5. Press “+” or “-” button to set the acceleration value. → Indicator lights L1-L5 will indicate the different acceleration values. The more the indicator lights will be on, the faster the speed changes.
6. Press” SET” button once to save and system will automatically exit. → The indicator lights L1-L5 will be on in sequence, then all will flicker once and off.

B. Operation Graphic Illustration

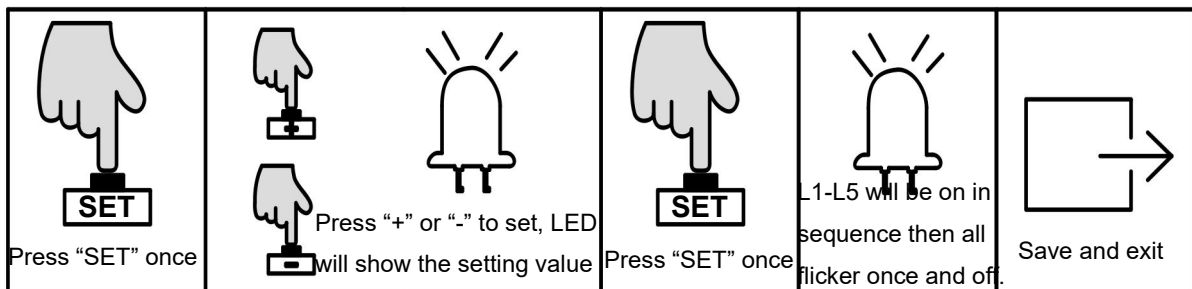
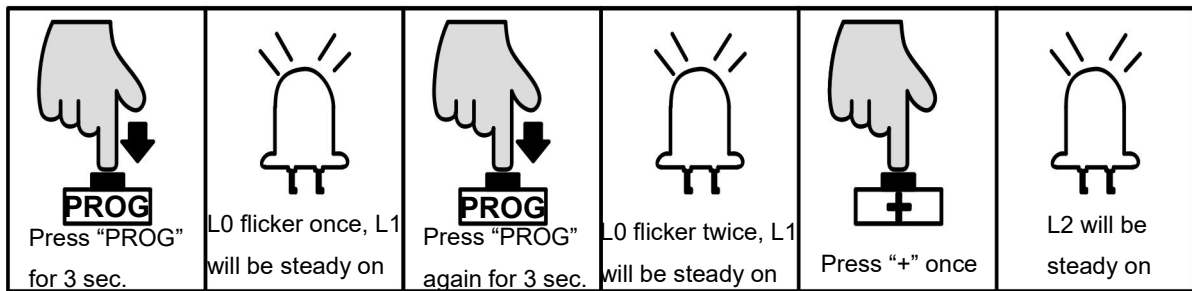

Start-up Delay Setting (L3)

The control board of this product is with low power consumption function under standby mode. When the gate opener stopped working, the control board will automatically enter into low power consumption mode to reduce the power consumption and extend the using time of the battery. Meanwhile, in order to reduce the power consumption of external accessories under standby mode, the control board will turn off the power for infrared sensor after entering into standby mode. When the gate opener is about to operate, it'll supply the power for accessories. In order to ensure the reliability of the infrared sensor, it is requested that the control board performs delay detection to the input signal of infrared sensor. When the gate opener receives the opening/closing signal, it'll start to work after a certain time (the settled delay time)

A. Operation Instruction:

1. Press and hold "PROG" button for 3 sec. to enter into basic menu. → Indicator light L0 will flicker once, then L1 will be steady on.
2. Press "PROG" button again for 3 sec. to enter into advanced menu. → L0 will flicker

twice, then L1 will be steady on.

3. Press “+” button twice to select start-up delay setting. → Indicator light L3 will be steady on.
4. Press “SET” button once to enter into start-up delay setting. → Indicator lights L1-L3 will show the current setting. (The default is L1)
5. Press “+” or “-” button to set the start-up delay time. → Indicator lights L1-L3 will show the current setting. (Table 2 Start-up Delay Time)
6. Press “SET” button once to save and system will automatically exit. → The indicator lights L1-L5 will be on in sequence, then all will flicker once and off.

B. Operation Graphic Illustration

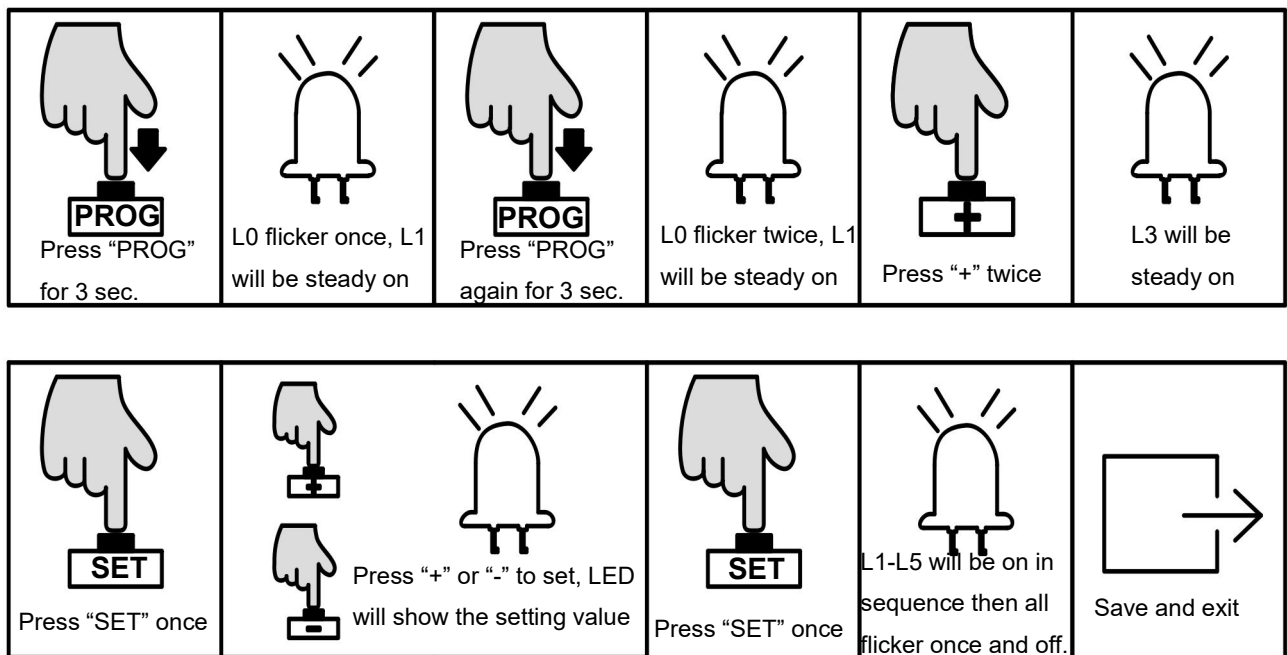

Indicator light status: <input type="checkbox"/> Off <input checked="" type="checkbox"/> On <input type="checkbox"/> Flicker	Status Instruction
L1 <input type="checkbox"/> L2 <input type="checkbox"/> L3 <input type="checkbox"/> L4 <input type="checkbox"/> L5 <input type="checkbox"/>	Cancel start-up delay function
L1 <input checked="" type="checkbox"/> L2 <input type="checkbox"/> L3 <input type="checkbox"/> L4 <input type="checkbox"/> L5 <input type="checkbox"/>	Delay for 0.5 sec
L1 <input checked="" type="checkbox"/> L2 <input checked="" type="checkbox"/> L3 <input type="checkbox"/> L4 <input type="checkbox"/> L5 <input type="checkbox"/>	Delay for 1 sec
L1 <input checked="" type="checkbox"/> L2 <input checked="" type="checkbox"/> L3 <input checked="" type="checkbox"/> L4 <input type="checkbox"/> L5 <input type="checkbox"/>	Delay for 1.5 sec

Table 2 Start-up Delay Time

Opening Direction Setting (L4)

This setting is for users to change the gate opening direction without exchanging the motor wires, but have to note the limit stop position.

A. Operation Instruction:

1. Press and hold "PROG" button for 3 sec. to enter into basic menu. → Indicator light L0 will flicker once, then L1 will be steady on.
2. Press "PROG" button again for 3 sec. to enter into advanced menu. → L0 will flicker twice, then L1 will be steady on.
3. Press "+" button three times to select opening direction option. → Indicator light L4 will be steady on.
4. Press "SET" button once to enter into opening direction setting. → Indicator light L1 will indicate the current setting. (Default is L1 on)
5. Press "+" or "-" button to set the opening direction. → Indicator light L1 on or off stands for the 2 directions. (L1 on: open to right-hand; L1 off: open to left-hand)

Press "SET" button once to save and system will automatically exit. → The indicator lights L1-L5 will be on in sequence, then all will flicker once and off.

B. Operation Graphic Illustration

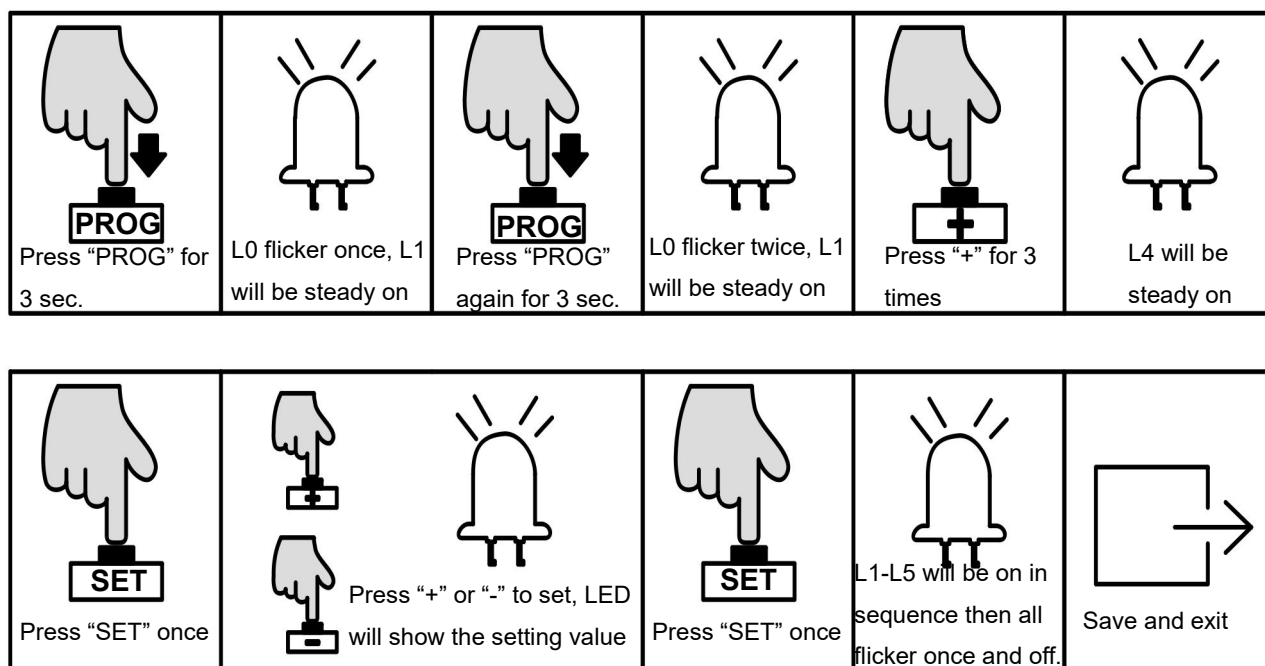

Note: After changing the opening direction, L1 and L2 will flicker together, it's a notice that reminding you to re-set the running travel for the gate. Before re-setting, it's extremely important to enter into manual control mode to confirm the polarities of the limit switch stops are correct and well contacted to the magnetic limit switch.

Alarm Lamp Setting(L5)

This setting is to select the working mode of alarm lamp (blinker or steady on)

A. Operation Instruction:

1. Press and hold "PROG" button for 3 sec. to enter into basic menu. → Indicator light L0 will flicker once, then L1 will be steady on.
2. Press "PROG" button again for 3 sec. to enter into advanced menu. → L0 will flicker twice, then L1 will be steady on.
3. Press "+" button four times to select alarm lamp working mode option. → Indicator light L5 will be steady on.
4. Press "SET" button once to enter into alarm lamp working mode setting. → Indicator

light L1 will show the current setting.

5. Press “+” or “-” button to set the alarm lamp working mode. → Indicator light L1 on or off will indicate the alarm lamp working mode. (L1 off: steady on; L1 on: blinker)
6. Press “SET” button once to save and system will automatically exit. → The indicator lights L1-L5 will be on in sequence, then all will flicker once and off.

B. Operation Graphic Illustration

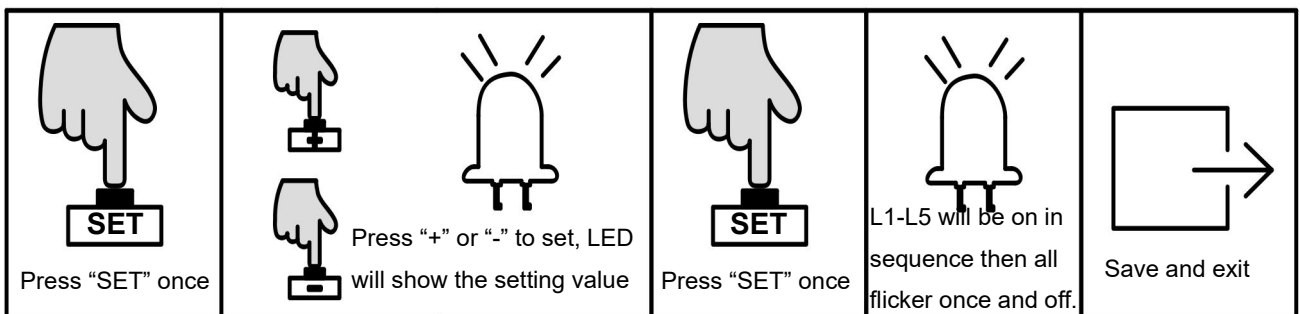
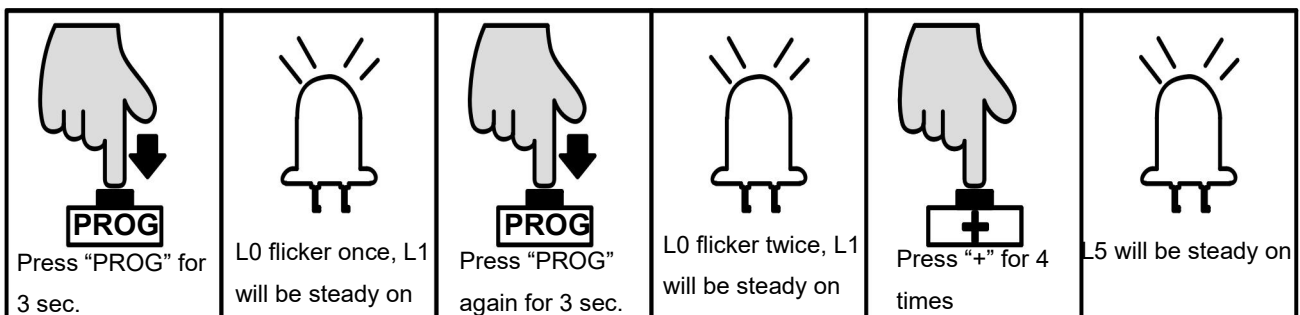

Other Menu Setting

1. Press “PROG” button for 3 Sec. under the standby mode, indicator light L0 will flicker once to enter into basic menu setting. Press “PROG” button again for 3 sec. indicator light L0 will flicker twice to enter into the advanced menu setting. Then press “PROG” button for 3 sec., the indicator light L0 will flicker three times then enter into other menu setting.
2. Different functions can be selected through “+” and “-” buttons.
3. Press “SET” button to enter into the selected function settings.

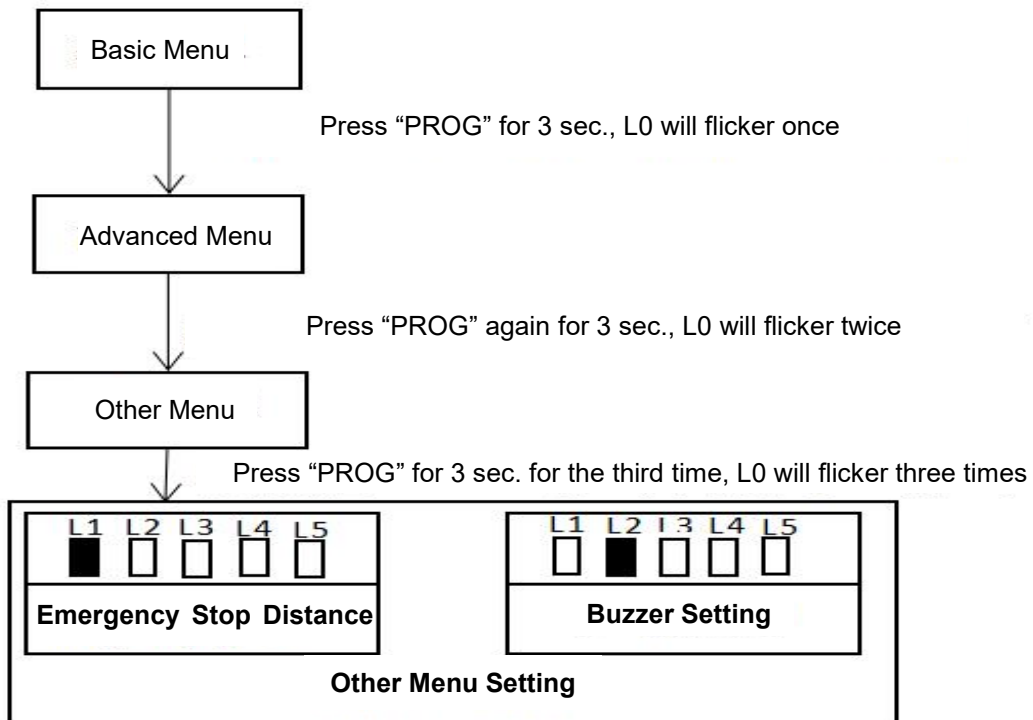

Figure 29

Emergency Stop Distance Setting(L1)

This setting is to change the distance of emergency stop during gate running. A longer distance will reduce the damage to the gate brings by impact force of emergency stop. Users can set the distance to their required.

A. Operation Instruction:

1. Press and hold "PROG" button for 3 sec. to enter into basic menu. → Indicator light L0 will flicker once, then L1 will be steady on.
2. Press "PROG" button again for 3 sec. to enter into advanced menu. → L0 will flicker twice, then L1 will be steady on.
3. Press "PROG" button for 3 sec. for the third time to enter into other menu setting. → L0 will flicker three times, then L1 will be steady on.
4. Press "SET" button once to enter into emergency stop distance setting. → Indicator light L1 to L5 will show the current setting value. (Default is L2)

5. Press “+” or “-” button to set the emergency stop distance. → Indicator lights L1-L5 will indicate different distance, the more the indicator lights are on, the longer the distance will be, the better the buffering will be before gate stopped.
6. Press “SET” button once to save and system will automatically exit. → The indicator lights L1-L5 will be on in sequence, then all will flicker once and off.

B. Operation Graphic Illustration

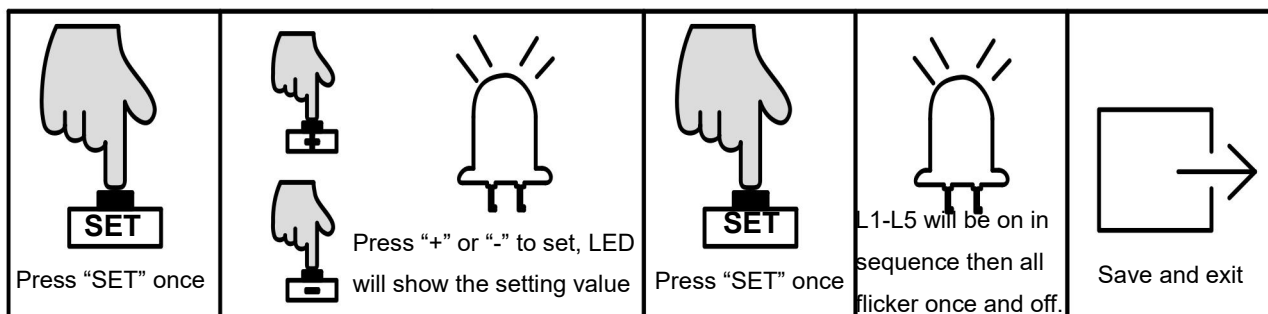
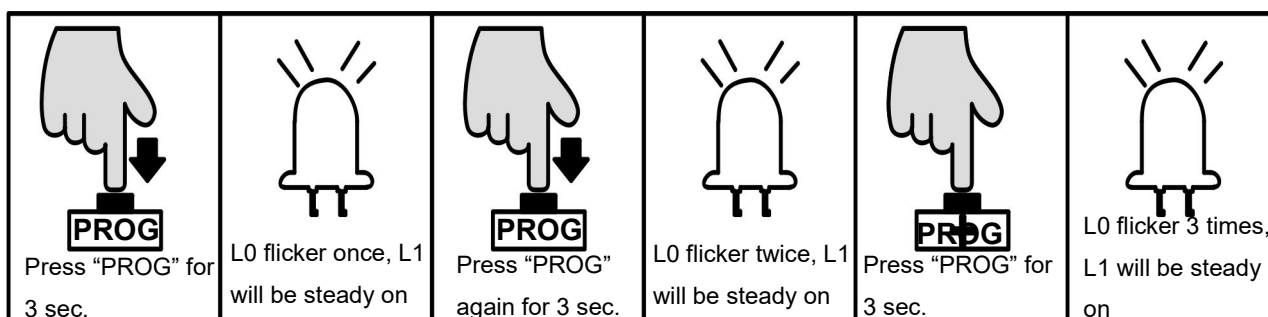

Note:

1. This function can directly affect the infrared emergency stop effect. Non professionals should not adjust it.
2. Only when the emergency stop distance is set to the minimum (only L0 lights up), the door opener will immediately stop and retreat to the closed position after triggering infrared when closing the door. But the impact force generated during an emergency stop will reduce the lifespan of the door opener.
3. When the emergency stop distance increases (excluding "minimum emergency stop distance"), the door opener will slowly slide for a certain distance before stopping and

retreating to the closing position after triggering infrared when closing the door. This setting can effectively reduce the damage caused to the door opener during emergency stop, but the emergency stop triggered by infrared is no longer sensitive when closing the door. Please adjust it as needed to be careful not to cause personal injury and property damage due to improper setting.

Buzzer Setting(L2)

This setting is to enable or disable the buzzer, users can set to their required.

There are four types of buzzer this motor will make for different conditions:

1. Motor works normally under mains power: the buzzer sounds short but long lasting.
2. Motor works normally under battery power: the buzzer sounds strident but long lasting, and will stop after 6 sec.
3. Motor works abnormal due to low battery power: the buzzer sounds strident but long lasting, and will stop after 3 sec.
4. Motor works abnormal due to control board error: the buzzer sounds strident but long lasting.

A. Operation Instruction:

1. Press and hold "PROG" button for 3 sec. to enter into basic menu. → Indicator light L0 will flicker once, then L1 will be steady on.
2. Press "PROG" button again for 3 sec. to enter into advanced menu. → L0 will flicker twice, then L1 will be steady on.
3. Press "PROG" button for 3 sec. for the third time to enter into other menu setting. → L0 will flicker three times, then L1 will be steady on.
4. Press "+" button twice to select buzzer setting option. → Indicator light L2 will be steady on.
5. Press "SET" button once to enter into buzzer setting. → Indicator light L1 on or off will

indicate the current setting value. (Default is L1 off)

6. Press “+” or “-” button to enable or disable the buzzer. → Indicator light L1 off: enable; on: disable.
7. Press “SET” button once to save and system will automatically exit. → The indicator lights L1-L5 will be on in sequence, then all will flicker once and off.

B. Operation Graphic Illustration

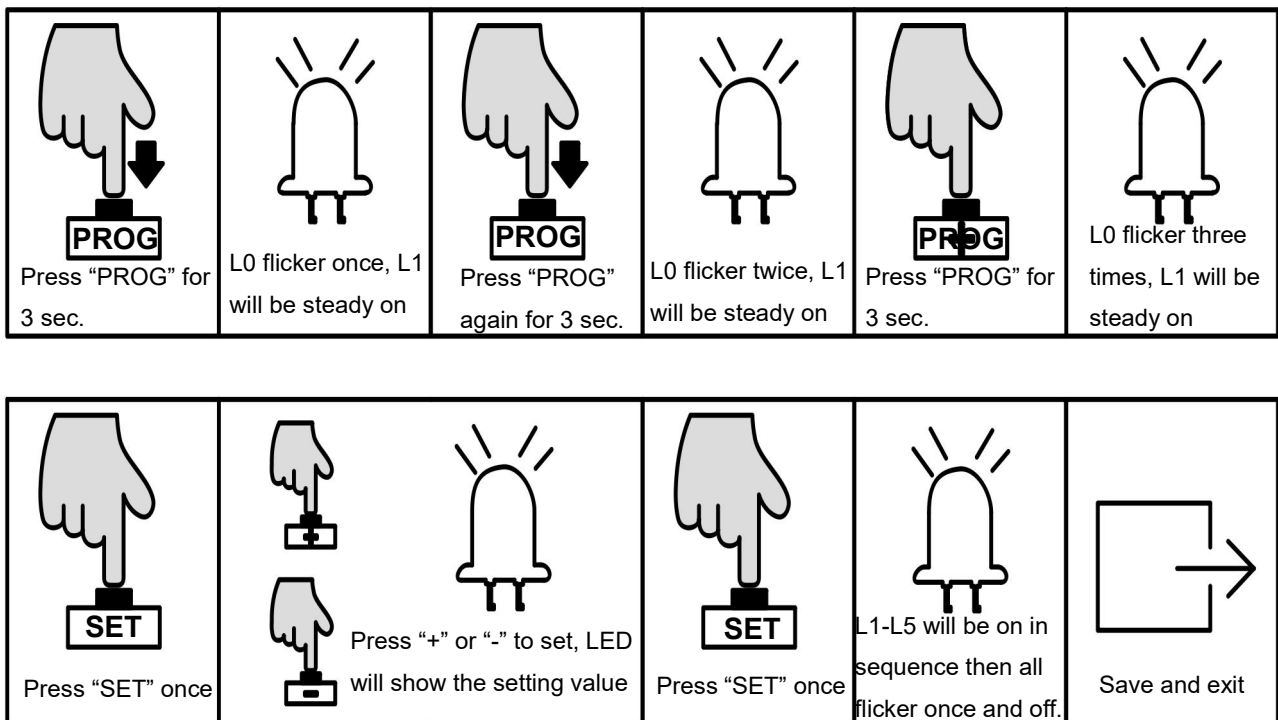

Note: The buzzer cannot be disabled under battery powered.

After turning on the buzzer function, when the motor is running normally and the buzzer is still not working, please check whether the "JP3 terminal" is inserted at the ON end.

Battery Level Checking

The current battery level can be checked through the indicator lights. When the battery power is low (battery voltage < 11.3V), the gate opener will stop running to protect the battery being damaged. Under such circumstance, users may have to unlock the gate

opener first, then move the gate by hand.

A. Operation Instruction:

1. Press “SET” button once. → Indicator lights L1-L5 will indicate the current battery level (Table 3 Battery Level)
2. Press “PROG” button once to exit the battery level checking. → Indicator lights L1-L5 will be off.

B. Operation Graphic Illustration

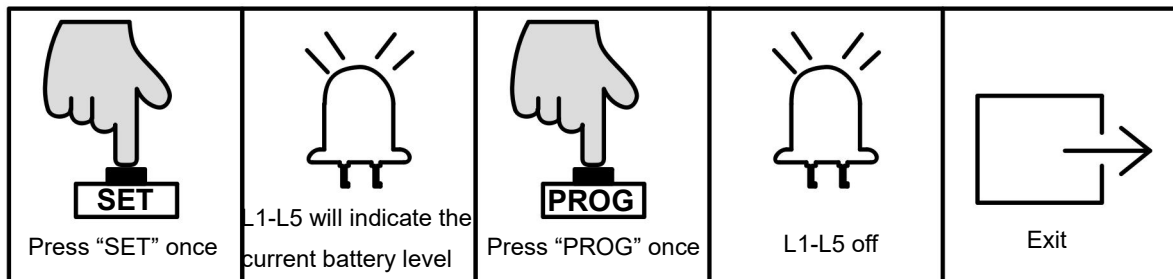

Indicator Light Status	Off	On	Flicker	Status Instruction						
L1	■	L2	■	L3	■	L4	■	L5	■	Battery Level $\geq 12.6V$
L1	■	L2	■	L3	■	L4	■	L5	□	Battery Level $\geq 12.3V$
L1	■	L2	■	L3	■	L4	□	L5	□	Battery Level $\geq 12.0V$
L1	■	L2	■	L3	□	L4	□	L5	□	Battery Level $\geq 11.7V$
L1	■	L2	□	L3	□	L4	□	L5	□	Battery Level $\geq 11.3V$
L1	□	L2	□	L3	□	L4	□	L5	□	Battery Level $< 11.3V$

Table 3 Battery Level

Restore Factory Setting

1. Simultaneously press the three buttons “SET”、“+” and “-” for 3 sec. → The indicator lights L1-L5 will be on in sequence, then all will flicker once and off. Save and exit.

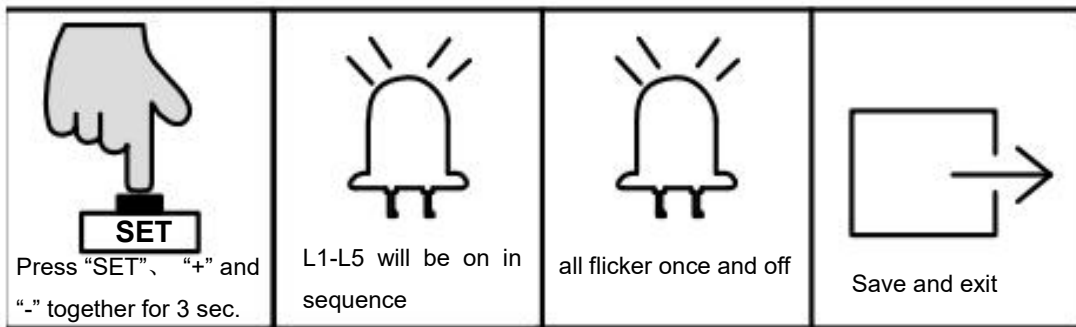

Control Board Error Instruction

The indicator light will display the error during gate running:

Indicator Light Status: <input type="checkbox"/> Off <input checked="" type="checkbox"/> Flicker	Status Instruction
L1 <input checked="" type="checkbox"/> L2 <input type="checkbox"/> L3 <input type="checkbox"/> L4 <input type="checkbox"/> L5 <input type="checkbox"/>	Meeting obstacles during gate opening
L1 <input type="checkbox"/> L2 <input checked="" type="checkbox"/> L3 <input type="checkbox"/> L4 <input type="checkbox"/> L5 <input type="checkbox"/>	Meeting obstacles during gate closing
L1 <input type="checkbox"/> L2 <input type="checkbox"/> L3 <input checked="" type="checkbox"/> L4 <input type="checkbox"/> L5 <input type="checkbox"/>	Running time over 60S
L1 <input type="checkbox"/> L2 <input type="checkbox"/> L3 <input type="checkbox"/> L4 <input type="checkbox"/> L5 <input checked="" type="checkbox"/>	Infrared photocell disconnecting
L1 <input checked="" type="checkbox"/> L2 <input type="checkbox"/> L3 <input checked="" type="checkbox"/> L4 <input type="checkbox"/> L5 <input type="checkbox"/>	No hall sensor
L1 <input checked="" type="checkbox"/> L2 <input checked="" type="checkbox"/> L3 <input type="checkbox"/> L4 <input type="checkbox"/> L5 <input type="checkbox"/>	No travel

Table 4 Error Instruction

Maintenance

The gate should be checked every month to make sure it operates normally.

For the sake of safety, each gate is suggested to be equipped with infrared protector, and regular inspection is required.

Before installation and operation of the gate opener, please read all instructions carefully.

Our company keep the right to change the instruction without prior notice.

Troubleshooting

Any troubleshooting work below done to the motor must be completed by a licensed electrician and only whilst the power is off and the motor is unplugged!

Problem	Possible Reason	Solution
The gate cannot open or close normally, indicator light doesn't on.	<ol style="list-style-type: none"> 1. The power supply is disconnected. 2. Fuse is blown. 3. Control board X2 terminal wrongly wired. 	<ol style="list-style-type: none"> 1. Connect the power supply. 2. Check the fuse (FU) and replace if blown. 3. Re-wiring according to this user manual.
The gate can only open, can't close.	<ol style="list-style-type: none"> 1. Photocell wrongly wired. 2. Photocell wrongly installed. 3. Photocell is blocked by objects. 4. Sensitivity of meeting obstacle is too high. 	<ol style="list-style-type: none"> 1. If not connect photocell, please ensure the infrared terminal and GND terminal has a jumper wire; if connect photocell, please ensure the wiring is correct and the photocell type is N.C. 2. Ensure that the photocell mounting position can be mutually aligned. 3. Remove the obstacle. 4. Reduce the sensitivity of obstacle.
Remote control doesn't work.	<ol style="list-style-type: none"> 1. Battery level is too low. 2. Remote control not paired. 	<ol style="list-style-type: none"> 1. Change the battery. 2. Pair the remote control to the gate opener.
Press OPEN, CLOSE button, the gate is not moving, motor has noise.	<ol style="list-style-type: none"> 1. Gate moving is not smoothly. 2. Hall sensor damaged. 	<ol style="list-style-type: none"> 1. Adjust the motor or gate according to the actual situation. 2. Replace the hall sensor.
Arrived at open or closed limit switch, but motor didn't stop.	<ol style="list-style-type: none"> 1. Magnetic limit switch damaged. 2. Polarities of the two limit switch stops are opposite. 3. Hall sensor part damaged. 	<ol style="list-style-type: none"> 1. Change the magnetic limit switch. 2. Switch over the two limit switch stops. 3. Change the hall sensor part.
Leakage switch tripped.	Power supply wires short circuit or motor wires short circuit.	Check wiring.

Drawing and Measurements

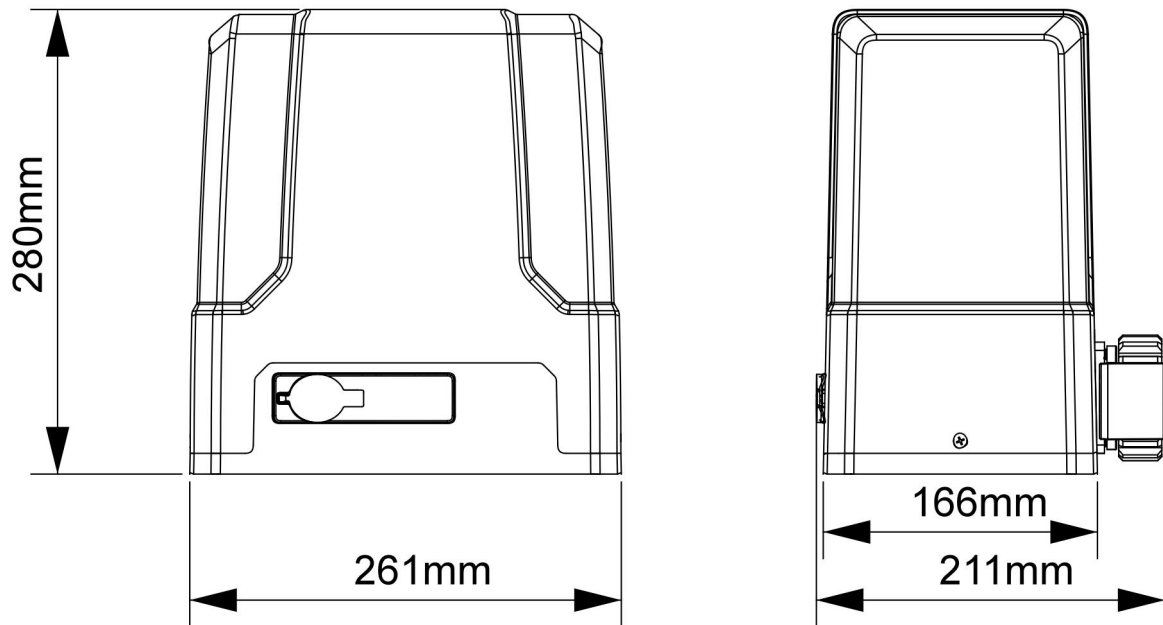

Figure 30

Warranty

Warranty Ordinance

1. To repair against this warranty card and invoice during the warranty period.
 2. Warranty period: 1 year after the date of invoice.
 3. Without unauthorized dismantling, any product broken or damage due to quality problem, we'll offer the repair service for free or replace for free.
 4. The malfunction and damaged caused by incorrect use or man fault is not covered by this warranty.
-

Maintenance Record

Check Date	Check Content	Maintained by